

RSA ELECTRIC ROD-STYLE ACTUATORS

ENDURANCE TECHNOLOGYSM
A Tolomatic Design Principle



RSA-HT



RSA-ST

RSA Electric Rod-Style Actuators

WHAT ARE THE RSA & THE GSA?





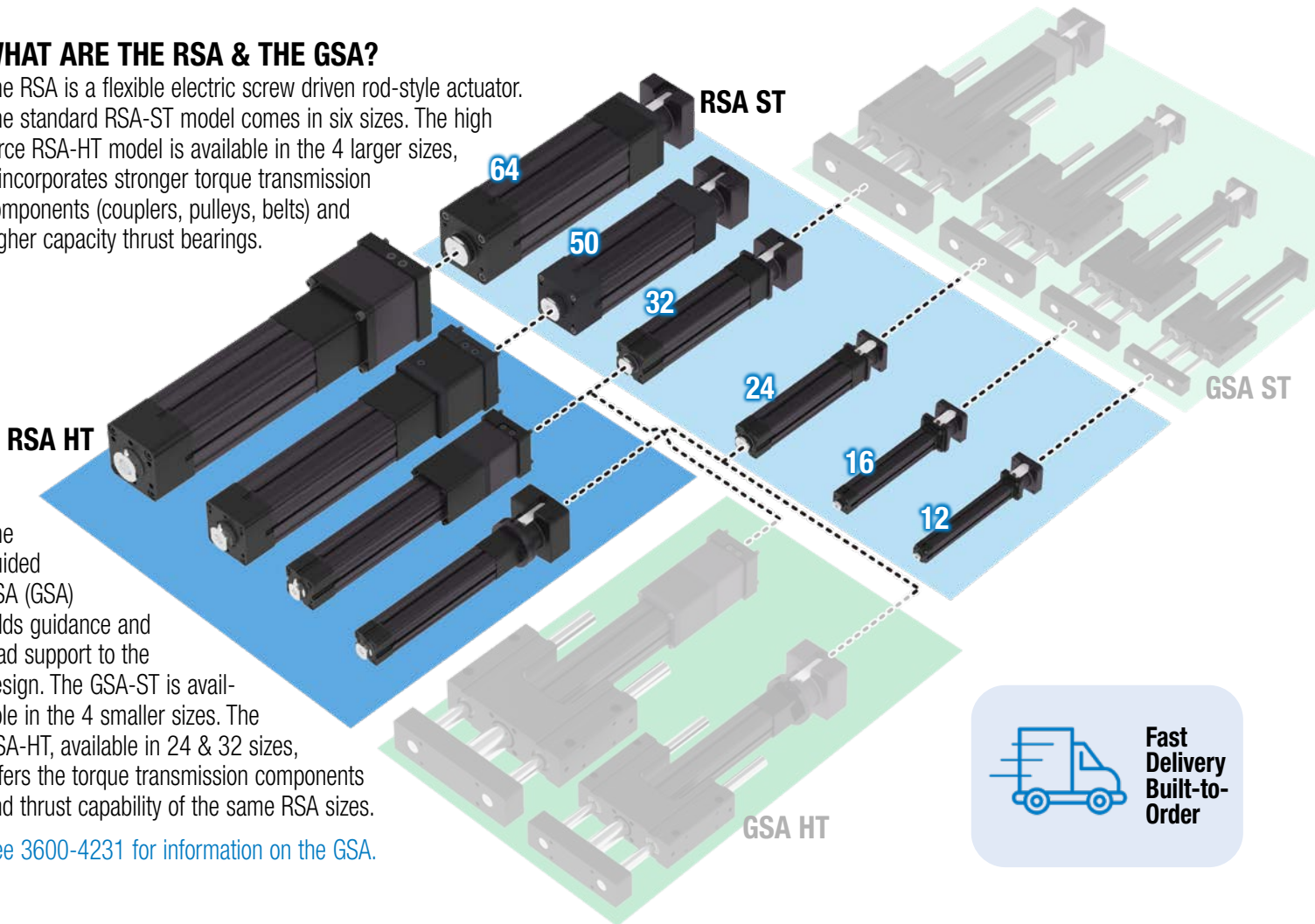

The RSA is a flexible electric screw driven rod-style actuator. The standard RSA-ST model comes in six sizes. The high force RSA-HT model is available in the 4 larger sizes, it incorporates stronger torque transmission components (couplers, pulleys, belts) and higher capacity thrust bearings.

The guided RSA (GSA) adds guidance and load support to the design. The GSA-ST is available in the 4 smaller sizes. The GSA-HT, available in 24 & 32 sizes, offers the torque transmission components and thrust capability of the same RSA sizes.

See 3600-4231 for information on the GSA.



TOLOMATIC'S ELECTRIC ROD-STYLE ACTUATORS

	ERD	RSH	RSA	RSX	GSA	IMA
						
	Rod-Style Actuator	Hygienic Rod-Style Actuator	Rod-Style Actuator	Rod-Style Actuator	Guided Rod-Style Actuator	Integrated Servo Actuator
Force up to:	2.2 kN (500 lbf)	35 kN (7,943 lbf)	58 kN (13,039 lbf)	294 kN (66,000 lbf)	18.5 kN (12,760 lbf)	35.8 kN (8,044 lbf)
Speed up to:	1,016 mm/sec (40 in/sec)	498 mm/sec (19.6 in/sec)	3,124 mm/sec (123 in/sec)	760 mm/sec (29.9 in/sec)	3,124 mm/sec (123 in/sec)	1,334 mm/sec (52.5 in/sec)
Stroke Length up to:	609 mm (24 in)	1,219 mm (48 in)	1,524 mm (60 in)	1,500 mm (59 in)	914 mm (36 in)	457 mm (18 in)
Screw/Nut Type	Solid & Ball	Ball & Roller	Solid, Ball & Roller	Ball & Roller	Solid & Ball	Ball & Roller
<i>For complete information see www.tolomatic.com or literature number:</i>						
Literature Number:	2190-4000	2100-4010	3600-4233	2171-4001	3600-4231	2700-4000

(Not all models deliver maximum values listed, i.e.: Maximum thrust may not be available with maximum speed)

RSA-ST

RSA Electric Rod-Style Actuators

Applications

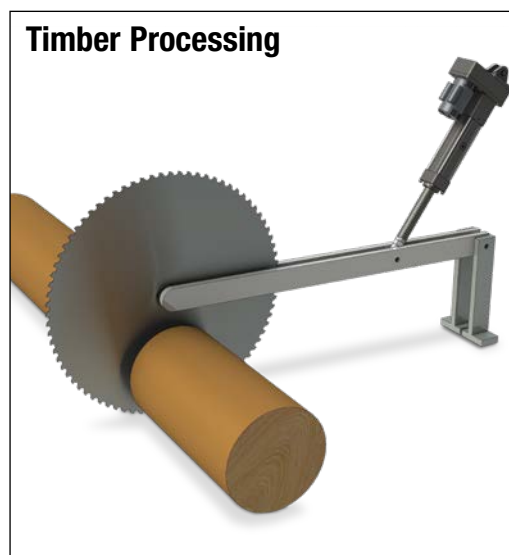
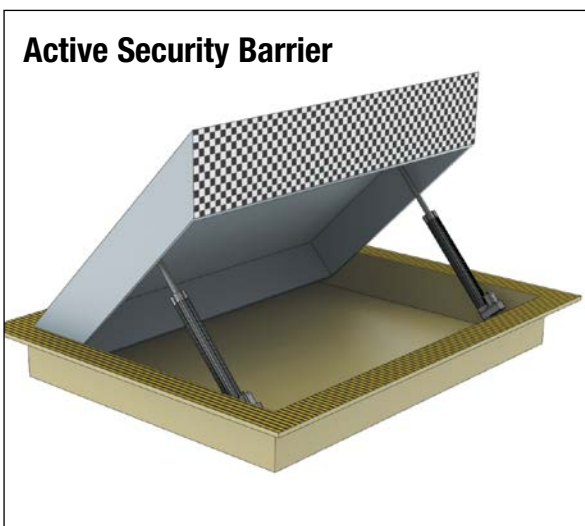
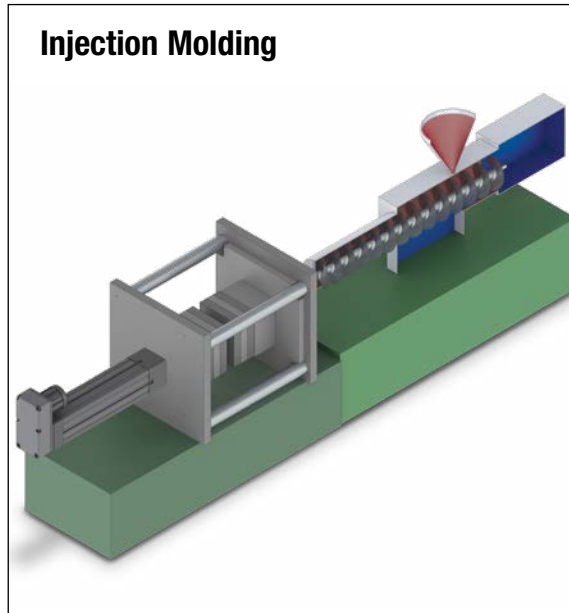
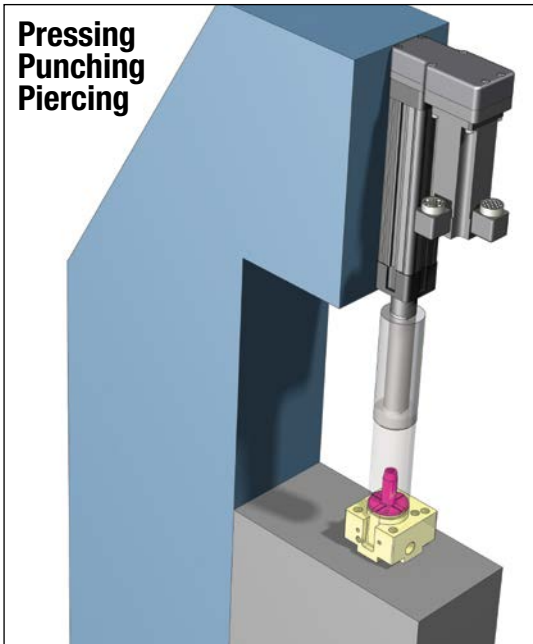

Other Applications:

- Animation
- Assembly machinery
- Automatic tool changers
- Automotive
- Clamping
- Converting
- Conveyors
- Cycle testing
- Fillers
- Formers
- Hydraulic replacement
- Laser positioning
- Machine tools
- Material handling
- Medical equipment
- Molding
- Motion simulators
- Open / close doors
- Packaging equipment
- Parts clamping
- Patient lifts
- Pick & place
- Pneumatic replacement
- Precision grinders
- Product test simulations
- Riveting / fastening / joining
- Robot manipulator arms
- Sawmill equipment
- Semiconductor
- Stage motion control
- Stamping
- Table positioning
- Tension control
- Test stands
- Tube bending
- Volumetric pumps
- Water jet control
- Wave generation
- Web guidance
- Welding
- Wire winding
- and many more

CONTENTS

What are RSA & GSA	RSA_2
Rod-Style Actuators	RSA_2
Applications	RSA_3
RSA ST Features	RSA_4
RSA HT Features	RSA_6
RSA Options	RSA_6
GSA Features	RSA_8
RSA ST	RSA_10
Specifications	RSA_10
Performance	RSA_12
Specifications	RSA_18
Dimensions	RSA_18
Option Dimensions	RSA_20
RSA HT	RSA_28
Specifications	RSA_28
Performance	RSA_30
Specifications	RSA_34
Dimensions	RSA_36
Option Dimensions	RSA_38
SWITCHES	RSA_42
Appl. Data Worksheet	RSA_44
Selection Guidelines	RSA_45
Service Parts Ordering	RSA_46
RSA ORDERING	RSA_47
Tolomatic Difference	RSA_48

RSA-ST ROD-STYLE ACTUATOR

Tolomatic... MAXIMUM DURABILITY
EXCELLENCE IN MOTION

ENDURANCE TECHNOLOGYSM

A Tolomatic Design Principle

Endurance Technology features are designed for maximum durability to provide extended service life.

The RSA rod screw actuator is ideal for medium to high thrust applications of guided loads. The compact design and cylinder style operation make this solution ideal for applications that were historically solved with pneumatic or hydraulic power. Many mounting options are available allowing the actuator to be installed in numerous applications. Built-to-order in stroke lengths up to 60 in (1.5 m) with your choice of screw technology.

YOUR MOTOR HERE

YOU CAN CHOOSE:

- Specify the device to be installed and actuator ships with proper mounting hardware
- Specify and ship your device to Tolomatic for factory installation
- Motor supplied and installed by Tolomatic

MOTOR ORIENTATION

YOU CAN CHOOSE:

- In-line option directly couples the driving shaft and is typically a one-piece housing construction for optimum alignment and support of the motor
- Reverse-parallel option minimizes the overall length, coupling motor and driving shaft via a belt with a 1:1 or 2:1 reduction ratio

MULTIPLE SCREW TECHNOLOGIES

YOU CAN CHOOSE:

- Solid nuts of bronze or engineered resins offer quiet performance at the lowest cost; anti-backlash available
- Ball nuts offer efficiency at a cost effective price; low-backlash available



HIGH POSITIONAL ACCURACY

SCREW ACCURACY

Roller Nut ± 0.0004 "/ft. ± 0.0102 mm/300mm
Metric Ball Nut ± 0.002 "/ft. ± 0.051 mm/300mm

SCREW SUPPORT BEARING

Engineered resin bearing provides continuous support of screw

THRUST TUBE

- Steel thrust tube supports extremely high force capabilities
- Salt bath nitride treatment provides excellent corrosion resistance, surface hardness and is very resistant to adherence of potential contaminants

INTERNAL BUMPERS

Bumpers protect the screw and nut assembly from damage at both ends of stroke

NOSE BEARING

- Support the thrust tube and nut assembly through entire stroke length
- Unique nose bearing material allows for smooth operation and support of the thrust rod

ROD WIPER

Prevents contaminants from entering the housing for extended life of the actuator

THREADED ROD END

Provides a common interface to multiple rod end options

HIGH THRUST BEARING

Unique high thrust bearing assembly design eliminates run-out and isolates the linear forces for the drive shaft

BREATHER/PURGE PORTS

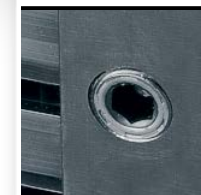

- Standard feature on RSA 32,50,64 size actuators
- As seen in this view, located on both the bottom and the opposite side of the actuator

• Use as Breather Port: allows air flow into the interior of the actuator. Prevents additional load on the motor caused by air buildup due to fast cycling of the RSA.
Use as Purge Port: positive pressure with air lines and filters insure contaminants (which could potentially shorten the actuator life) do not enter the interior of the actuator.

LIGHTWEIGHT ALUMINUM DESIGN

- Black anodized extrusion design is optimized for rigidity and strength
- External switch channels on all sides allow easy placement of position indicating switches

INTERNAL NUT BEARINGS

- Engineered resin guide bearings provide anti-rotation of the thrust rod
- Support the thrust tube and nut assembly through entire stroke length

OPTIONS

See page 7 for a complete list of RSA options including the HT-high torque option

RSA-HT OPTION

ENDURANCE TECHNOLOGYSM

A Tolomatic Design Principle

The HT option is a higher thrust option for the 24, 32, 50 and 64 sizes of the RSA family. RSA actuators with roller nuts are always HT option actuators. Use Tolomatic's online sizing software to determine if the HT Option is right for your application

STANDARD FEATURES
See page 4 for a complete list of RSA standard features

REDESIGNED LMI & RP HOUSING

Specially designed to accommodate larger motors & gearboxes with higher torques and larger bolt circles (up to 6.5", 165mm)

DURABLE BELT MATERIAL

High torque polyurethane timing belt with carbon tensile cords resists stretching

ENHANCED HIGH THRUST BEARING

RSA HT actuators come with high thrust angular contact ball bearing in matched pair assembly design which eliminates run-out and isolates the linear forces from the drive shaft

MULTIPLE SCREW TECHNOLOGIES

YOU CAN CHOOSE:

- Bronze solid nuts offer quiet performance at the lowest cost; anti-backlash available
- Ball nuts offer efficiency at a cost effective price; low-backlash available
- Roller nuts provide the highest thrust and life ratings available (HT option)



WHY CHOOSE THE HT OPTION?

- Higher strength components transfer torque from the gearhead/motor through the actuator
- Grease zerk allows convenient relubrication for extended screw service life
- Accommodates mounting large motors with up to 165mm bolt circle pattern

YOUR MOTOR HERE (Standard Feature)

YOU CAN CHOOSE:

- Specify the device to be installed and actuator ships with proper mounting hardware
- Specify and ship your device to Tolomatic for factory installation
- Motor or gearbox supplied and installed by Tolomatic

IP67 OPTION

Resist water ingress 1m deep for up to 30 min

HEAVY DUTY INTERNAL BUMPERS

Bumpers protect the screw and nut assembly from damage at both ends of stroke

Tolomatic... MAXIMUM DURABILITY

EXCELLENCE IN MOTION

OPTIONS (Available for all RSA actuators unless noted)

• METRIC OPTION

Provides metric tapped holes for mounting of load to rod end and of actuator to mating surfaces



• SWITCHES

Choose from: Reed, Solid State PNP or NPN, all available normally open or normally closed

• IP67

Static: special gaskets for basic protection against water and dust ingress
32,50,64 sizes only: HT actuator (LMI and RP); ST actuator (RP motor mount only)

ROD END



• MET: External Threads male threads

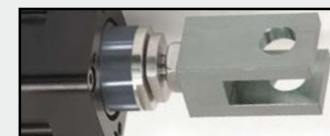

• CLV: Clevis Rod End for pivoting mount



• SRE: Spherical Rod End for pivoting mount



• ALC: Alignment Coupler Rod End to compensate for mounting alignment



• XR: Rod Extension to separate load from the actuator

MOUNTING



• MP2: Mounting Plates for surface mounting



• FFG: Front Flange for mounting near rod end



• TRR: Trunnion Mount for pivoting mount

Below are for RP Motor mounting only



• BFG: Rear Flange for mounting opposite the rod end



• PCS: Eye Mount for pivoting mount

THREADED ROD END

Provides a common interface to multiple rod end options

GREASE ZERK

- This relubrication system provides extended screw service life
- Convenient lubrication without disassembly
- Standard with all HT option RSA actuators
- Grease zerk orientation is not pre-defined. Custom orientation can be requested as a product modification

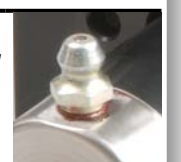

RSA ST Electric Rod-Style Actuator

SIZE: ALL

units: US standard

SPECIFICATIONS



sizeit.tolomatic.com
for fast, accurate
actuator selection

RSA SIZE	MAX STROKE	SCREW TYPE	SCREW LEAD	MAX THRUST*	DYNAMIC LOAD RATING**	LEAD ACCURACY†	BACKLASH	SCREW DIAMETER	BASE ACTUATOR INERTIA	INERTIA PER in OF STROKE	MAXIMUM DYNAMIC FRICTION TORQUE
	in		turns/in								
12	12	SN01	1.00	70	N/A	0.0100	0.0070	0.375	0.007	0.002	0.7
	12	SN02	2.00	70	N/A	0.0060	0.0070	0.375	0.004	0.001	0.6
	12	SN05	5.00	70	N/A	0.0060	0.0070	0.375	0.003	0.001	0.7
	12	BZ10	10.00	70	N/A	0.0060	0.0080	0.375	0.003	0.001	0.8
	12	BN(L)08	8.00	130	300	0.0030	0.0150	0.375	0.003	0.001	0.5
16	18	SN01	1.00	70	N/A	0.0100	0.0070	0.375	0.009	0.002	1.4
	18	SN02	2.00	70	N/A	0.0060	0.0070	0.375	0.004	0.001	0.9
	18	SN05	5.00	70	N/A	0.0060	0.0070	0.375	0.003	0.001	0.8
	18	BZ10	10.00	70	N/A	0.0060	0.0080	0.375	0.003	0.001	1.2
	18	BN(L)08	8.00	130	300	0.0030	0.0150	0.375	0.003	0.001	0.5
24	24	SN02	2.00	200	N/A	0.0050	0.0070	0.625	0.082	0.005	1.9
	24	SN04	4.00	200	N/A	0.0100	0.0070	0.625	0.077	0.004	2.1
	24	SN08	8.00	200	N/A	0.0100	0.0070	0.625	0.075	0.004	2.3
	24	BZ10	10.00	603	N/A	0.0060	0.0080	0.625	0.075	0.004	3.7
	24	BN(L)05	5.00	825	1,411	0.0030	0.0150	0.625	0.076	0.004	2.4
	24	BN(L)02	2.00	342	1,071	0.0030	0.0150	0.500	0.082	0.003	2.4
	24	BNM05	5.08	868	2,697	0.0040	0.0030	0.630	0.076	0.004	2.5
32	24	BNM10	2.54	434	1,911	0.0040	0.0030	0.630	0.075	0.004	2.2
	36	BZ10	10.00	785	N/A	0.0060	0.0080	0.750	0.123	0.009	4.6
	36	BN(L)02	2.00	534	3,364	0.0040	0.0150	0.750	0.131	0.010	3.1
	36	BN(L)05	5.00	950	1,624	0.0030	0.0150	0.750	0.124	0.009	2.8
	36	BNM05	5.08	1,357	3,080	0.0040	0.0030	0.787	0.124	0.011	3.0
	36	BNM10	2.54	678	4,721	0.0040	0.0030	0.787	0.128	0.012	2.9
50	36	BNM20	1.27	339	2,560	0.0020	0.0050	0.787	0.143	0.013	3.2
	48	BZ10	10.00	1,784	N/A	0.0060	0.0080	1.000	0.551	0.028	13.0
	48	BN(L)01	1.00	758	2,300	0.0040	0.0150	1.000	0.640	0.035	6.4
	48	BN(L)02	2.00	1,517	5,355	0.0040	0.0150	1.000	0.572	0.030	6.3
	48	BN(L)04	4.00	3,034	5,159	0.0040	0.0150	1.000	0.555	0.028	7.0
	48	BNM05	5.08	2,347	4,035	0.0020	0.0040	0.984	0.553	0.028	7.0
	48	BNM10	2.54	1,926	3,372	0.0020	0.0040	0.984	0.564	0.029	9.1
64	48	BNM25	1.02	771	2,537	0.0040	0.0050	0.984	0.637	0.035	9.4
	60	BZ10	10.00	1,781	N/A	0.0060	0.0080	1.500	2.208	0.139	33.3
	60	BN(L)53	0.53	538	5,961	0.0040	0.0150	1.500	2.851	0.174	14.0
	60	BN(L)02	2.00	2,019	11,402	0.0040	0.0150	1.500	2.252	0.141	11.7
	60	BN(L)04	4.00	4,028	6,746	0.0040	0.0150	1.500	2.218	0.139	12.6
	60	BNM05	5.08	2,033	6,714	0.0020	0.0040	1.575	2.214	0.139	10.0
	60	BNM10	2.54	2,033	7,476	0.0020	0.0040	1.575	2.235	0.140	15.7
60	BNM20	1.27	1,282	5,528	0.0020	0.0050	1.575	2.320	0.145	16.1	

SCREW CODE	DESCRIPTION
BN	Ball Nut
BNH	Ball Nut H-series
BNL	Low-Backlash Ball Nut
BNM	Ball Nut Metric
BZ	Bronze Nut
RN	Roller Nut
SN	Solid Nut



Contact Tolomatic for higher accuracy and lower backlash options.
† (L) for low backlash ball screws: backlash = 0.0020" (0.05 mm)

* For SN & BZ screws, maximum continuous dynamic thrust subject to Thrust x Velocity limitation.

** For RN, BN & BNL screws, dynamic load rating reflects 90% reliability for 1 million revolutions.

RSA-ST

RSA ST Electric Rod-Style Actuator



SIZE: **ALL**

units: **metric****

SPECIFICATIONS

** RSA metric actuators use the same leadscrew as the RSA inch actuators. Threaded mounting and dowel pin holes are metric.

RSA SIZE	MAX STROKE mm	SCREW TYPE	SCREW LEAD mm/rev	MAX THRUST* N	DYNAMIC LOAD RATING** N	LEAD ACCURACY† mm/300mm	BACKLASH mm	SCREW DIAMETER mm	BASE ACTUATOR INERTIA kg-cm ²	INERTIA PER mm OF STROKE kg-cm ²	MAXIMUM DYNAMIC FRICTION TORQUE N-m
12	304.8	SN01	25.40	311	N/A	0.25	0.18	9.5	0.02	0.0002	0.08
	304.8	SN02	12.70	311	N/A	0.15	0.18	9.5	0.01	0.0001	0.07
	304.8	SN05	5.08	311	N/A	0.15	0.18	9.5	0.01	0.0001	0.08
	304.8	BZ10	2.54	311	N/A	0.15	0.20	9.5	0.01	0.0001	0.09
	304.8	BN(L)08	3.18	578	1,334	0.08	0.38	9.5	0.01	0.0001	0.06
16	457.2	SN01	25.40	311	N/A	0.25	0.18	9.5	0.03	0.0002	0.16
	457.2	SN02	12.70	311	N/A	0.15	0.18	9.5	0.01	0.0001	0.10
	457.2	SN05	5.08	311	N/A	0.15	0.18	9.5	0.01	0.0001	0.09
	457.2	BZ10	2.54	311	N/A	0.15	0.20	9.5	0.01	0.0001	0.14
	457.2	BN(L)08	3.18	578	1,334	0.08	0.38	9.5	0.01	0.0001	0.06
24	609.6	SN02	12.70	890	N/A	0.13	0.18	15.9	0.24	0.0006	0.21
	609.6	SN04	6.35	890	N/A	0.25	0.18	15.9	0.23	0.0005	0.24
	609.6	SN08	3.18	890	N/A	0.25	0.18	15.9	0.22	0.0005	0.26
	609.6	BZ10	2.54	2,682	N/A	0.15	0.20	15.9	0.22	0.0005	0.42
	609.6	BN(L)05	5.08	3,670	6,276	0.08	0.38	15.9	0.22	0.0005	0.27
	609.6	BN(L)02	12.70	1,521	4,764	0.08	0.38	12.7	0.24	0.0003	0.27
	609.6	BNM05	5.00	3,861	11,997	0.10	0.08	16.0	0.22	0.0005	0.28
32	914.4	BNM10	10.00	1,931	8,501	0.10	0.08	16.0	0.22	0.0005	0.25
	914.4	BZ10	2.54	3,492	N/A	0.15	0.20	19.1	0.36	0.0010	0.52
	914.4	BN(L)02	12.70	2,375	14,964	0.10	0.38	19.1	0.38	0.0011	0.35
	914.4	BN(L)05	5.08	4,226	7,224	0.08	0.38	19.1	0.36	0.0010	0.32
	914.4	BNM05	5.00	6,036	13,701	0.10	0.08	20.0	0.36	0.0013	0.34
	914.4	BNM10	10.00	3,016	21,000	0.10	0.08	20.0	0.38	0.0013	0.33
50	1219.2	BNM20	20.00	1,508	11,387	0.05	0.13	20.0	0.42	0.0015	0.36
	1219.2	BZ10	2.54	7,936	N/A	0.15	0.20	25.4	1.61	0.0032	1.47
	1219.2	BN(L)01	25.40	3,372	10,231	0.10	0.38	25.4	1.88	0.0041	0.72
	1219.2	BN(L)02	12.70	6,748	23,820	0.10	0.38	25.4	1.68	0.0034	0.71
	1219.2	BN(L)04	6.35	13,496	22,948	0.10	0.38	25.4	1.63	0.0033	0.79
	1219.2	BNM05	5.00	10,440	17,949	0.05	0.10	25.0	1.62	0.0032	0.79
	1219.2	BNM10	10.00	8,567	14,999	0.05	0.10	25.0	1.65	0.0033	1.03
64	1219.2	BNM25	24.90	3,430	11,285	0.10	0.13	25.0	1.87	0.0040	1.06
	1524	BZ10	2.54	7,922	N/A	0.15	0.20	38.1	6.47	0.0160	3.76
	1524	BN(L)53	47.92	2,393	26,516	0.10	0.38	38.1	8.35	0.0201	1.58
	1524	BN(L)02	12.70	8,981	50,719	0.10	0.38	38.1	6.60	0.0163	1.32
	1524	BN(L)04	6.35	17,917	30,008	0.10	0.38	38.1	6.50	0.0161	1.42
	1524	BNM05	5.00	9,043	29,865	0.05	0.10	40.0	6.49	0.0161	1.13
	1524	BNM10	10.00	9,043	33,255	0.05	0.10	40.0	6.55	0.0162	1.77
64	1524	BNM20	20.00	5,703	24,590	0.05	0.13	40.0	6.80	0.0167	1.82

SCREW CODE	DESCRIPTION
BN	Ball Nut
BNH	Ball Nut H-series
BNL	Low-Backlash Ball Nut
BNM	Ball Nut Metric
BZ	Bronze Nut
RN	Roller Nut
SN	Solid Nut



Contact Tolomatic for higher accuracy and lower backlash options.
 † (L) for low backlash ball screws: backlash = 0.0020" (0.05 mm)

* For SN & BZ screws, maximum continuous dynamic thrust subject to Thrust x Velocity limitation.

** For RN, BN & BNL screws, dynamic load rating reflects 90% reliability for 1 million revolutions.

RSA-ST

RSA ST Electric Rod-Style Actuator

SIZE: 12,16: CRITICAL SPEED CAPACITIES

SPECIFICATIONS



sizeit.tolomatic.com
for fast, accurate
actuator selection

RSA-ST

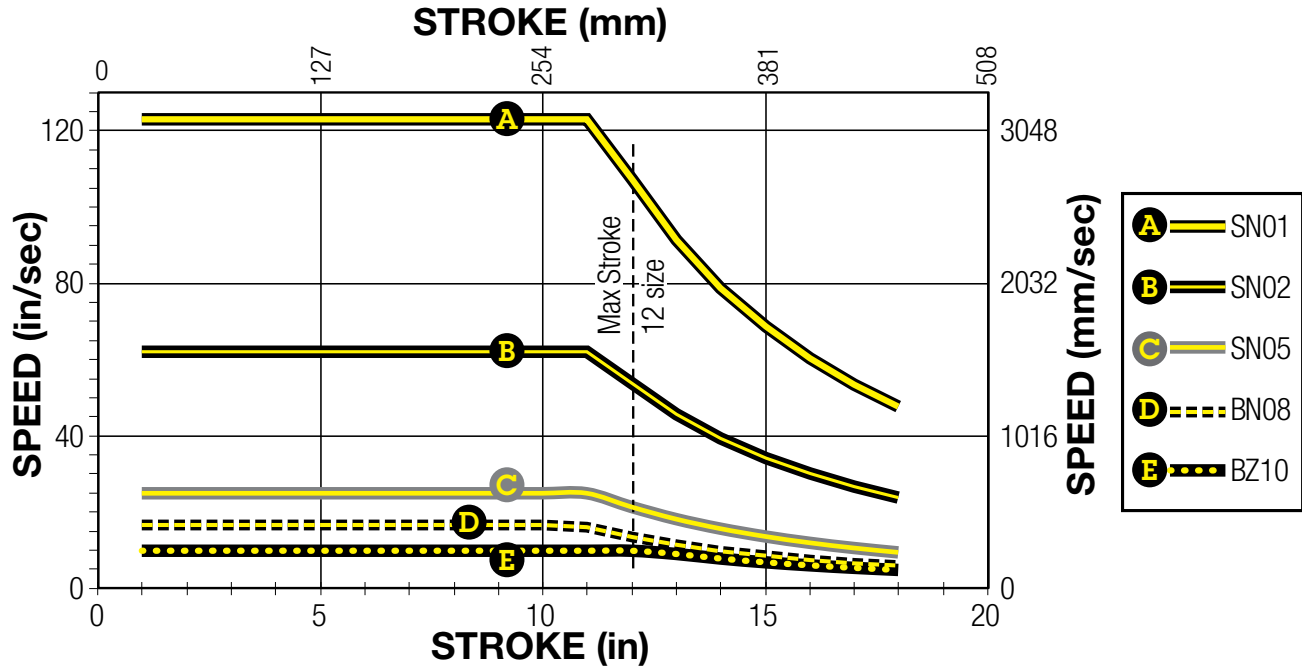

SIZE: 24: CRITICAL SPEED CAPACITIES

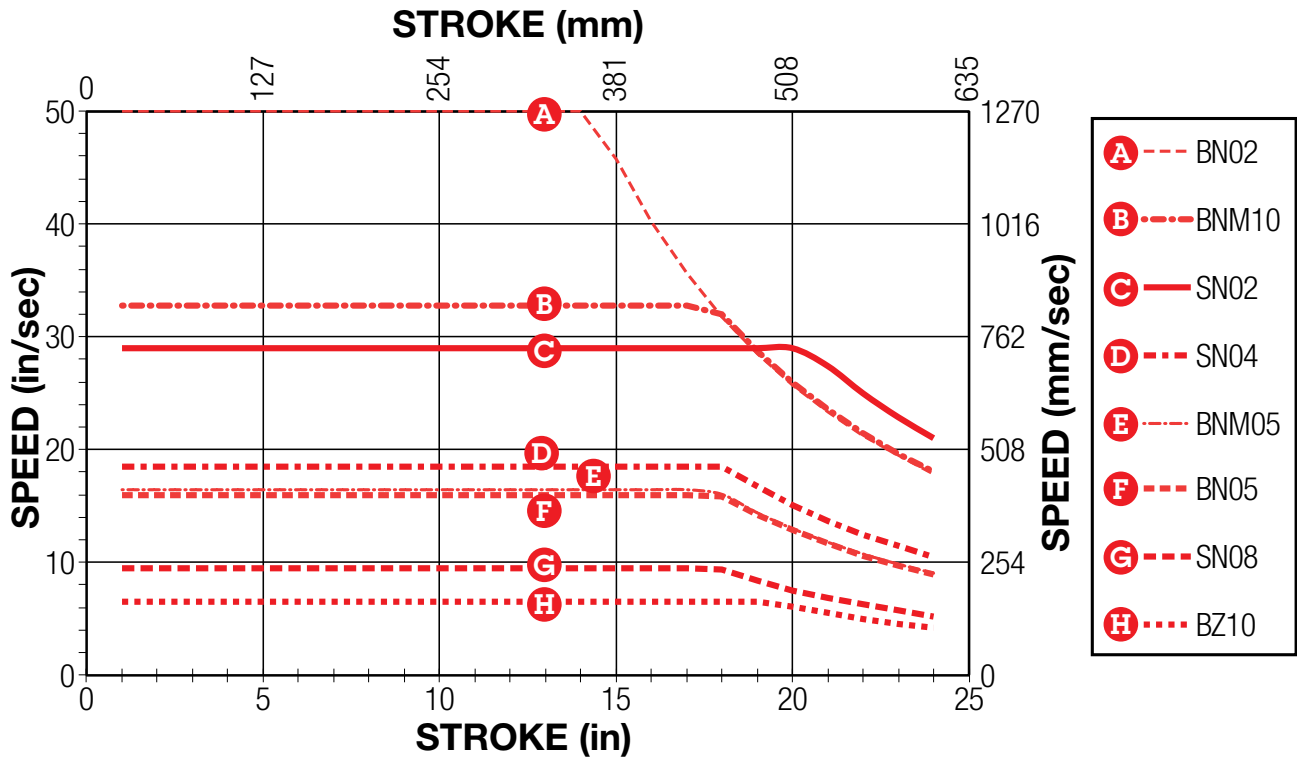

SCREW CODE	DESCRIPTION	SCREW CODE	DESCRIPTION
BN	Ball Nut	BZ	Bronze Nut
BNH	Ball Nut H-series	RN	Roller Nut
BNL	Low-Backlash Ball Nut	SN	Solid Nut
BNM	Ball Nut Metric		

RSA ST Electric Rod-Style Actuator

sizeit.tolomatic.com
for fast, accurate
actuator selection

SIZE: **32: CRITICAL SPEED CAPACITIES**

SPECIFICATIONS

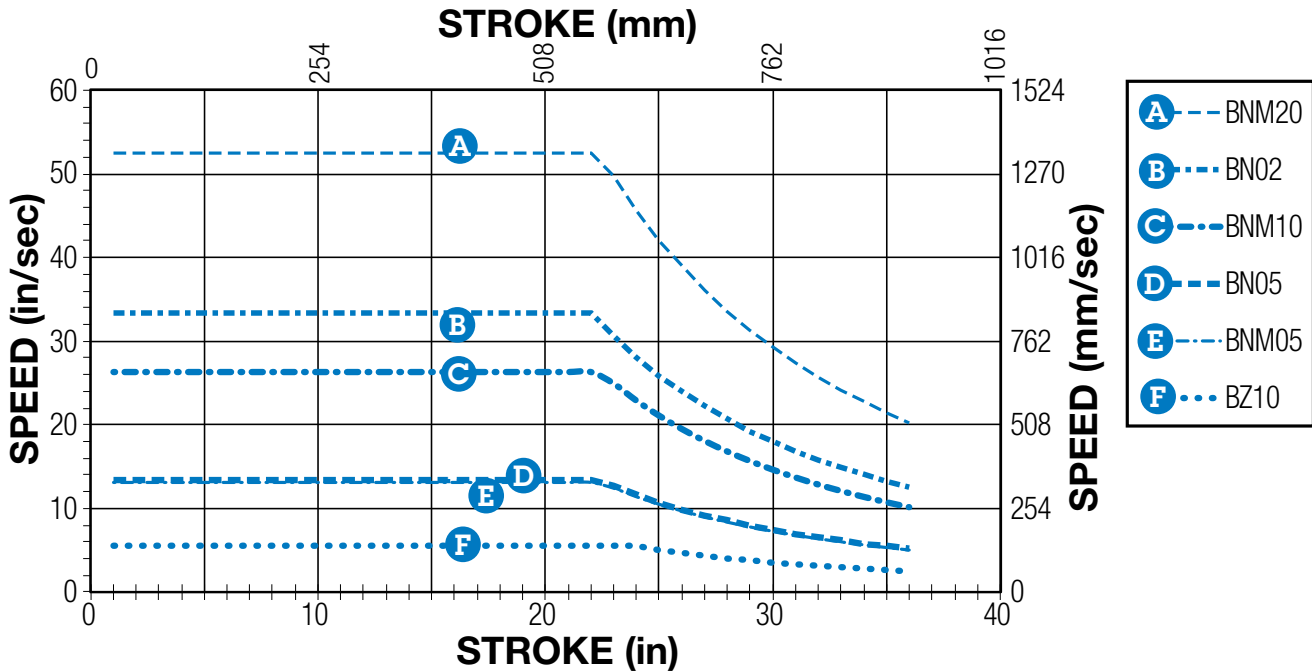

SIZE: **50: CRITICAL SPEED CAPACITIES**

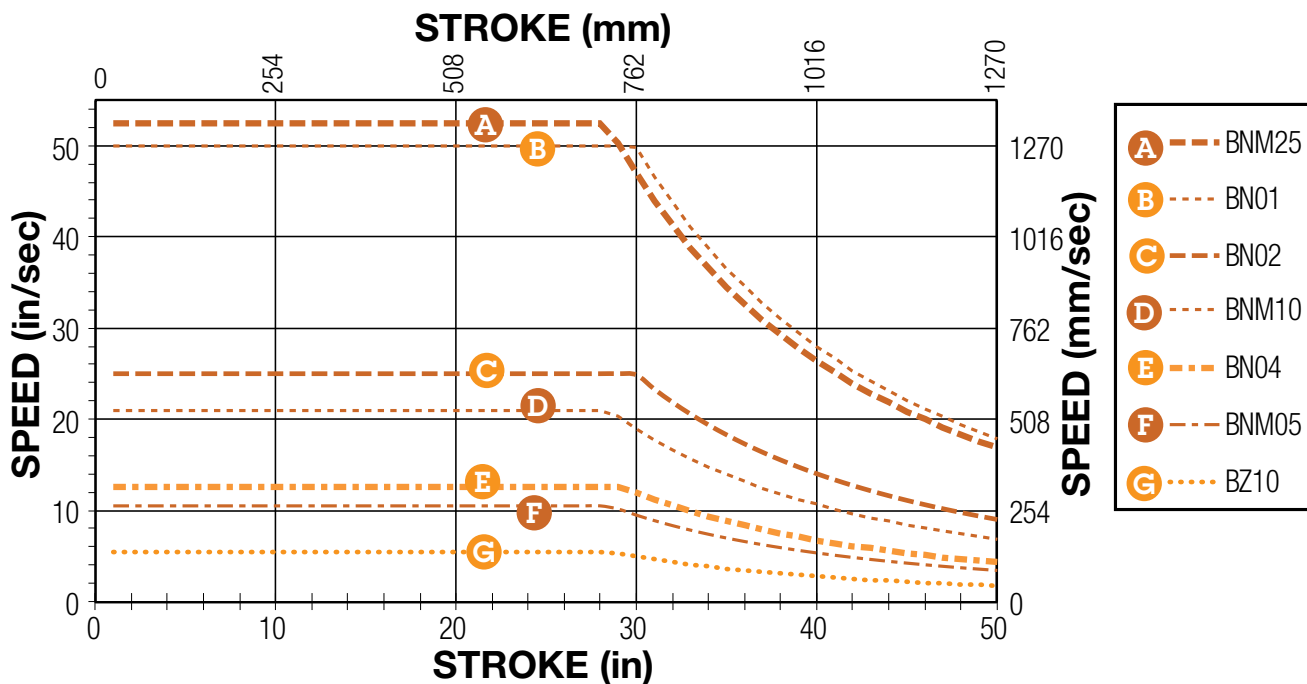

SCREW CODE	DESCRIPTION	SCREW CODE	DESCRIPTION
BN	Ball Nut	BZ	Bronze Nut
BNH	Ball Nut H-series	RN	Roller Nut
BNL	Low-Backlash Ball Nut	SN	Solid Nut
BNM	Ball Nut Metric		

RSA-ST

RSA ST Electric Rod-Style Actuator

sizeit.tolomatic.com
for fast, accurate
actuator selection

SIZE: 64: CRITICAL SPEED CAPACITIES

SPECIFICATIONS

RSA-ST

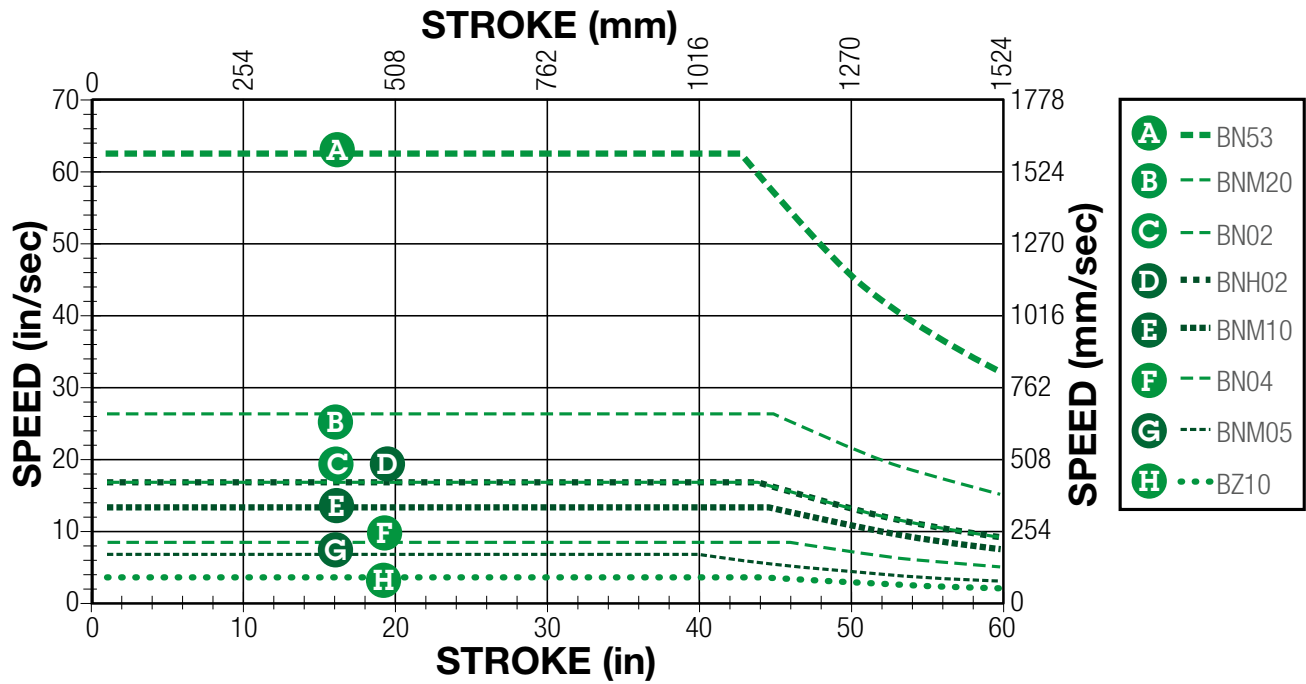

SIZE: 12,16: PV LIMITS (Solid Nuts)

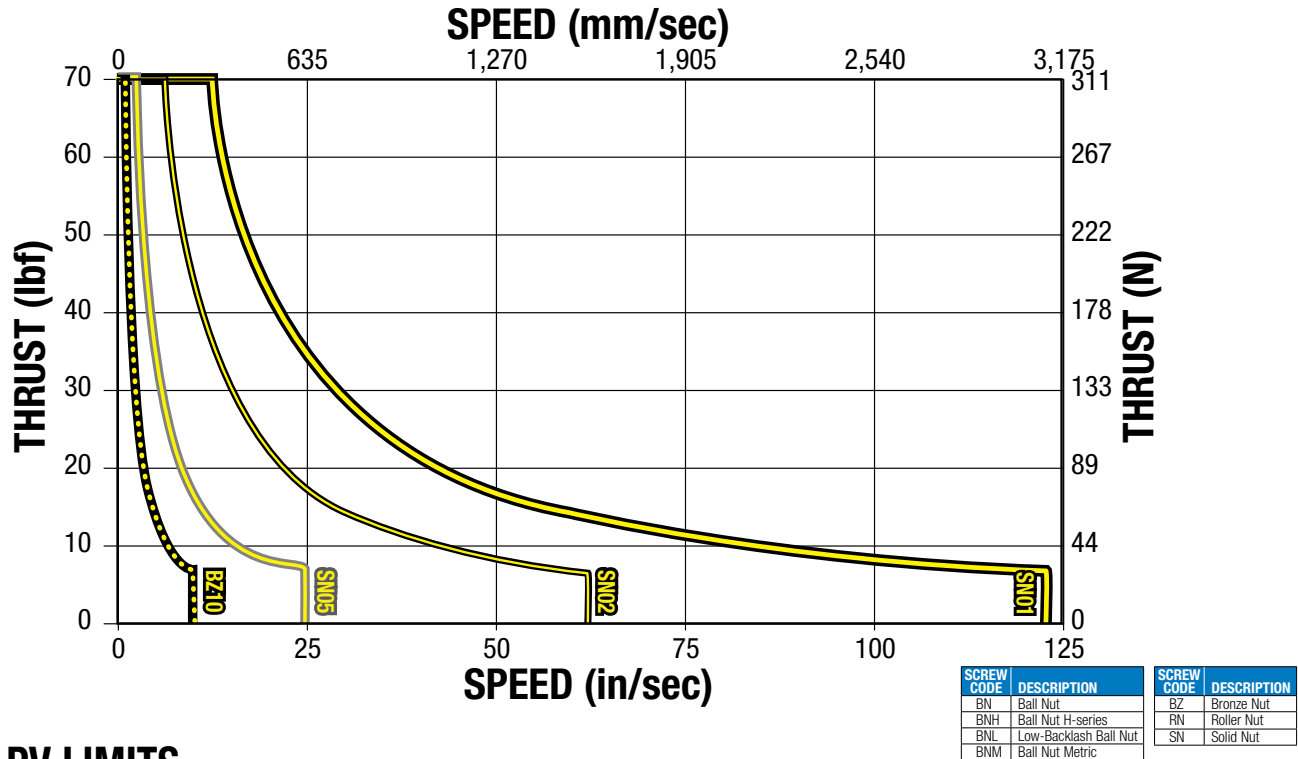

PV LIMITS

PV LIMITS: Any material which carries a sliding load is limited by heat buildup. The factors that affect heat generation rate in an application are the pressure on the nut in pounds per square inch and the surface velocity in feet per minute. The product of these factors provides a measure of the severity of an application.

$$\frac{P}{\text{(Max. Thrust Rating)}} \times \frac{V}{\text{(Max. Speed Rating)}} \leq 0.1$$

RSA ST Electric Rod-Style Actuator

sizeit.tolomatic.com
for fast, accurate
actuator selection

SIZE: 24 (SN): PV LIMITS (Solid Nuts)

SPECIFICATIONS

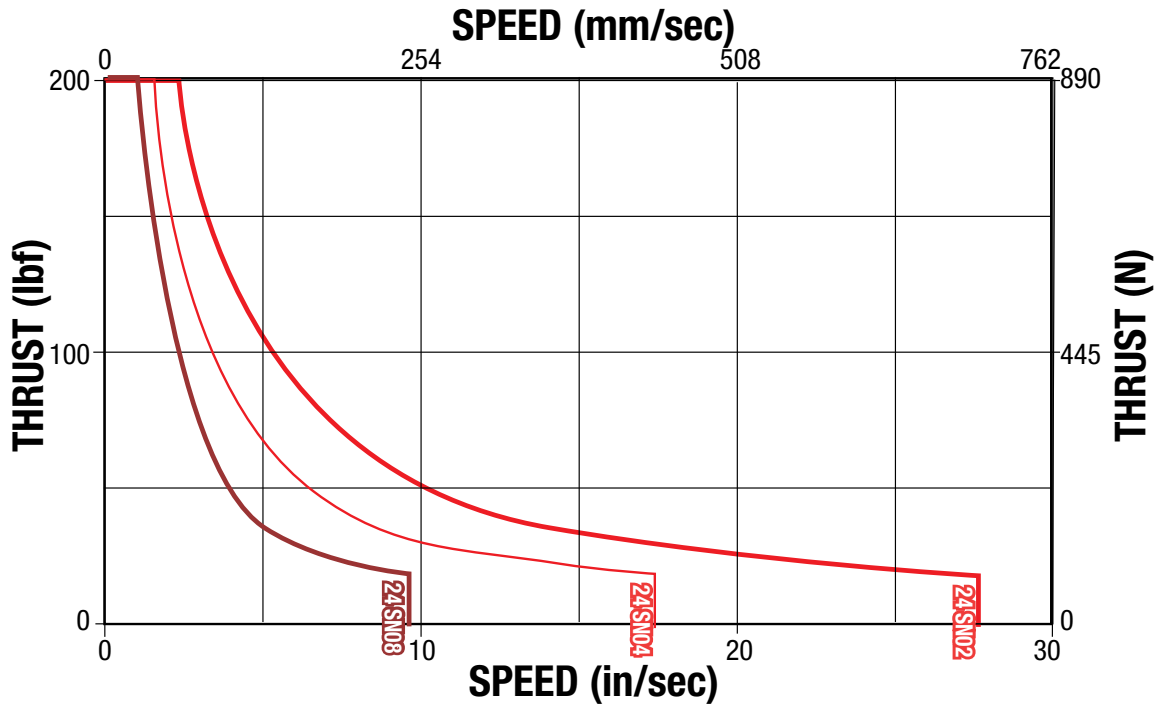

SIZE: 24,32,50,64 (BZ): PV LIMITS (Bronze Nuts)

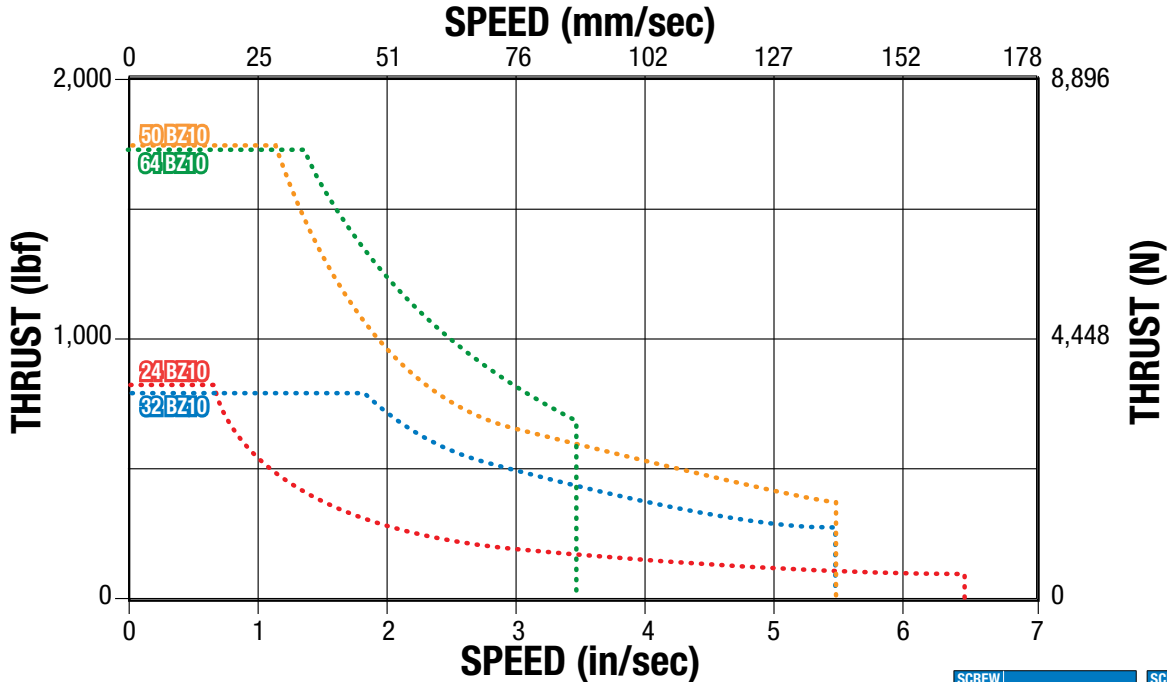

SCREW CODE	DESCRIPTION	SCREW CODE	DESCRIPTION
BN	Ball Nut	BZ	Bronze Nut
BNH	Ball Nut H-series	RN	Roller Nut
BNL	Low-Backlash Ball Nut	SN	Solid Nut
BNM	Ball Nut Metric		

PV LIMITS

PV LIMITS: Any material which carries a sliding load is limited by heat buildup. The factors that affect heat generation rate in an application are the pressure on the nut in pounds per square inch and the surface velocity in feet per minute. The product of these factors provides a measure of the severity of an application.

$$P \times V \leq 0.1$$

$$\left(\frac{\text{Thrust}}{(\text{Max. Thrust Rating})} \right) \times \left(\frac{\text{Speed}}{(\text{Max. Speed Rating})} \right) \leq 0.1$$

RSA-ST

RSA ST Electric Rod-Style Actuator



sizeit.tolomatic.com
for fast, accurate
actuator selection

BALL SCREW LIFE GRAPHS

SPECIFICATIONS

SIZE: 12, 16, 24, 32

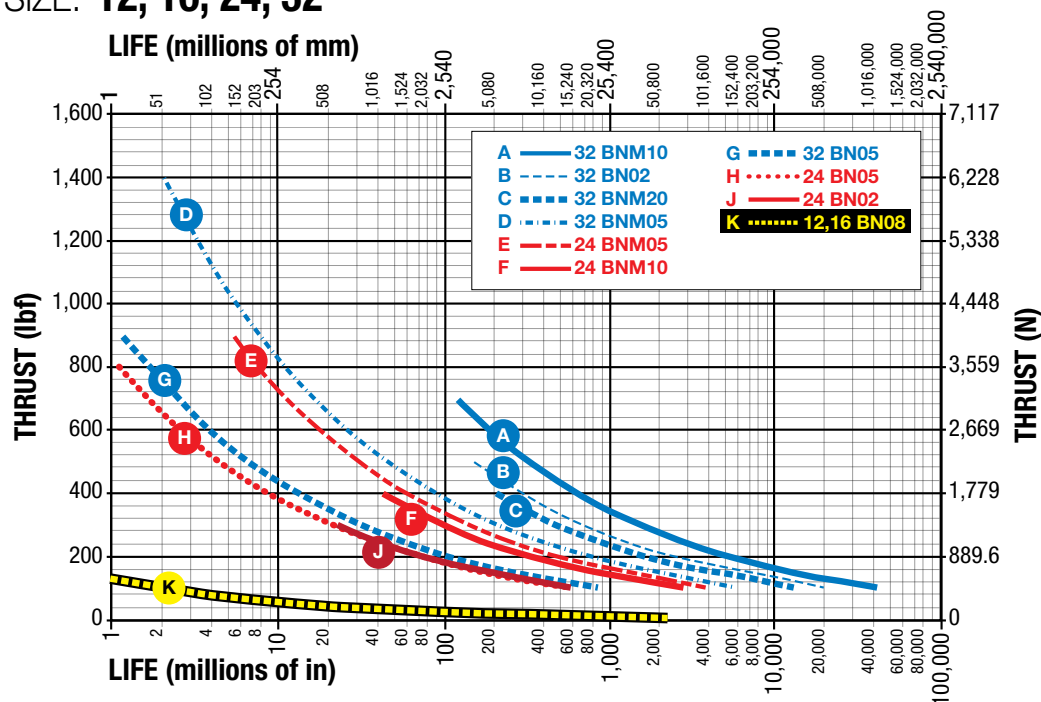

SCREW CODE	DESCRIPTION
BN	Ball Nut
BNH	Ball Nut H-series
BNL	Low-Backlash Ball Nut
BNM	Ball Nut Metric
BZ	Bronze Nut
RN	Roller Nut
SN	Solid Nut

SIZE: 50, 64

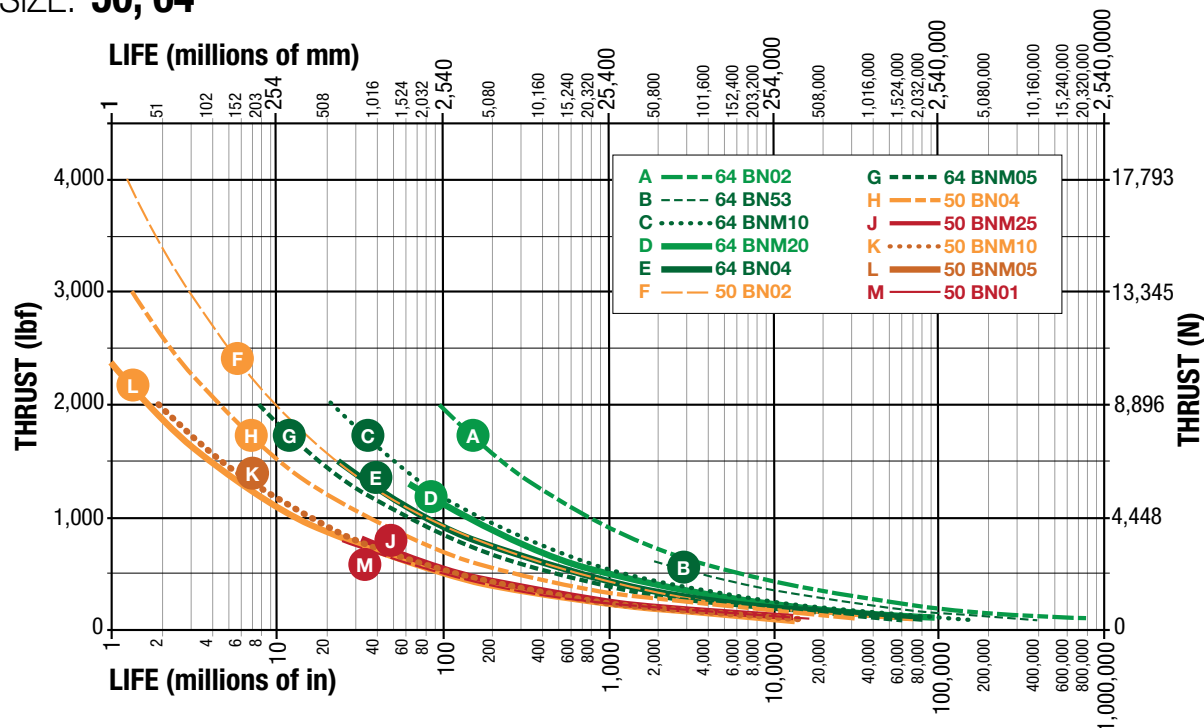

NOTE: The L_{10} expected life of a ball screw linear actuator is expressed as the linear travel distance that 90% of properly maintained ball screw manufactured are expected to meet or exceed. This is not a guarantee and this graph should be used for estimation purposes only.

The underlying formula that defines this value is:

$$L_{10} = \left(\frac{C}{P_e} \right)^3 \cdot \ell =$$

L_{10} Travel life in millions of units (in or mm), where:

C = Dynamic load rating (lbf) or (N)

P_e = Equivalent load (lbf) or (N)

If load is constant across all movements then:

actual load = equivalent load

ℓ = Screw lead (in/rev) (mm/rev)

Use the "Equivalent Load" calculation below, when the load is not constant throughout the entire stroke. In cases where there is only minor variation in loading, use greatest load for life calculations.

$$P_e = \sqrt[3]{\frac{L_1(P_1)^3 + L_2(P_2)^3 + L_3(P_3)^3 + L_n(P_n)^3}{L}}$$

Where:

P_e = Equivalent load (lbf) or (N)

P_n = Each increment at different load (lbf) or (N)

L = Total distanced traveled per cycle (extend + retract stroke)
[L = L₁ + L₂ + L₃ + L_n]

L_n = Each increment of stroke at different load (in) or (mm)

RSA ST Electric Rod-Style Actuator

sizeit.tolomatic.com
for fast, accurate
actuator selection

SCREW BUCKLING LOAD

SPECIFICATIONS

SIZE: 12, 16, 24, 32

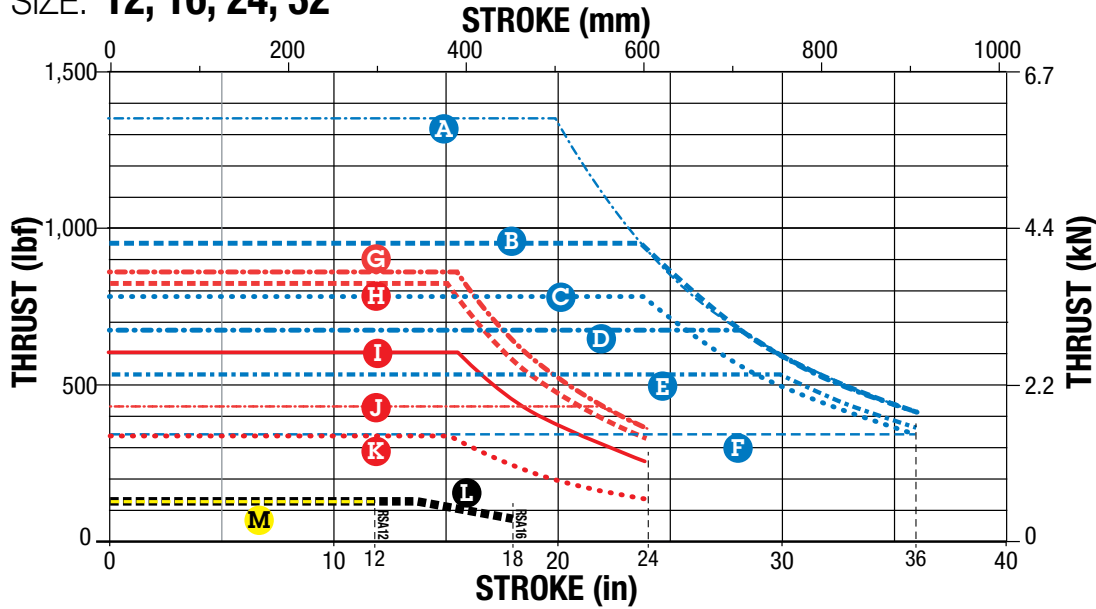

SIZE: 50

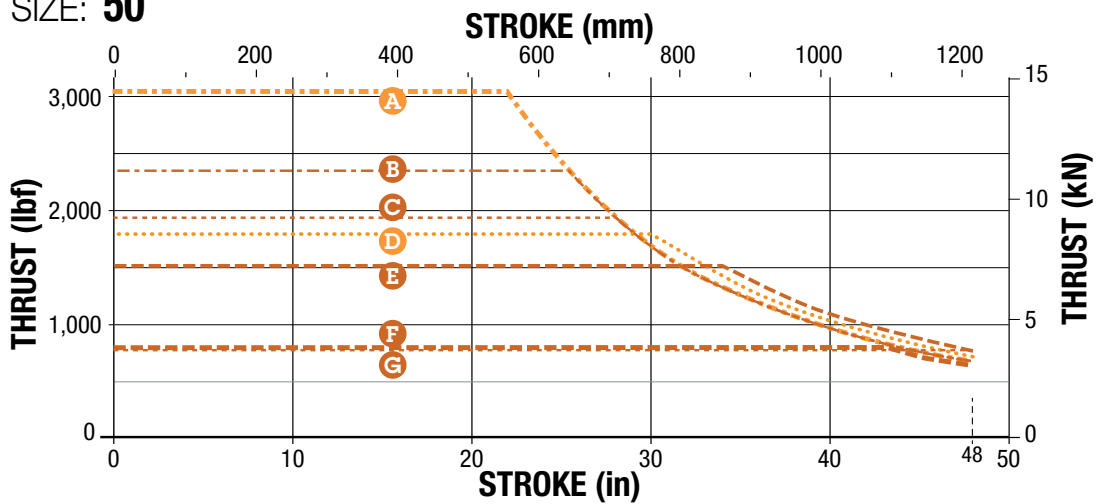

SIZE: 64

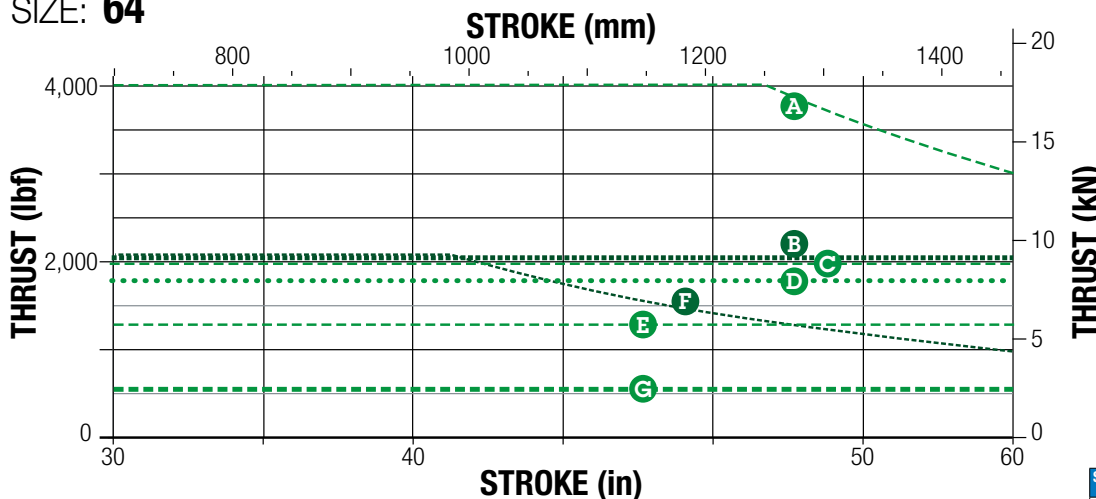

SCREW CODE	DESCRIPTION
BN	Ball Nut
BNH	Ball Nut H-series
BNL	Low-Backlash Ball Nut
BNM	Ball Nut Metric
BZ	Bronze Nut
RN	Roller Nut
SN	Solid Nut

NOTE: Buckling load limits shown assume perfect alignment. It is recommended to use additional safety margin, particularly in high thrust applications

RSA-ST

RSA ST Electric Rod-Style Actuator



sizeit.tolomatic.com
for fast, accurate
actuator selection

SIZE: ALL

SPECIFICATIONS

U.S. Standard

RSA SIZE	WEIGHT					REDUCTION INERTIA		
	BASE	LMI	RP1	RP2	per in of stroke	LMI	RP1	RP2
	lb	lb	lb	lb	lb/in	lb-in ²	lb-in ²	lb-in ²
12	0.5	0.9	0.7	N/A	0.10	0.03	0.15	N/A
16	0.6	0.9	0.8	N/A	0.16	0.03	0.15	N/A
24	2.8	0.9	1.7	2.2	0.34	0.03	0.15	0.12
32	5.3	1.4	2.8	3.2	0.48	0.18	0.16	0.16
50	12.2	2.2	4.9	5.2	0.84	0.56	0.68	0.40
64	30.8	5.6	8.7	11.5	1.45	0.56	0.82	1.92

*Temperature Range (°F): Standard: 40 to 130 Extended: -40 to 140

Metric

RSA SIZE	WEIGHT					REDUCTION INERTIA		
	BASE	LMI	RP1	RP2	per mm of stroke	LMI	RP1	RP2
	kg	kg	kg	kg	g/mm	kg-cm ²	kg-cm ²	kg-cm ²
12	0.23	0.41	0.32	N/A	1.79	0.0879	0.4395	N/A
16	0.27	0.41	0.36	N/A	2.86	0.0879	0.4395	N/A
24	1.27	0.41	0.77	1.00	6.07	0.0879	0.4395	0.3516
32	2.40	0.64	1.27	1.45	8.57	0.5274	0.4688	0.4688
50	5.53	1.00	2.22	2.36	15.00	1.6408	1.9924	1.1720
64	13.97	2.54	3.95	5.22	25.89	1.6408	2.4026	5.6256

*Temperature Range (°C): Standard: 4 to 54 Extended -40 to 60

Gasket Kit providing ingress protection against dust and splashing water available upon request



Contact Tolomatic if operation in the extended range is required.

⚠ * Heat generated by the motor and drive should be taken into consideration as well as linear velocity and work cycle time. For applications that require operation outside of the recommended temperature range, contact Tolomatic.

LARGE FRAME MOTORS AND SMALLER SIZE ACTUATORS: Cantilevered motors need to be supported, if subjected to continuous rapid reversing duty and/or under dynamic conditions.

SIDE LOADING CONSIDERATIONS: Rod screw actuators are designed to push guided and supported loads and are not meant for applications that require substantial side loading. Please contact Tolomatic for details regarding side loading capabilities.

REVERSE PARALLEL MOUNTING ORDER CODES

Note that these configurations all are shown with the tapped mounting holes at the bottom of the actuator

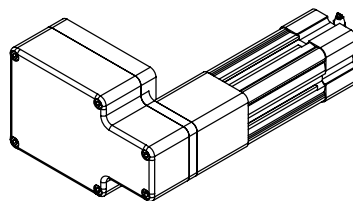

RPL

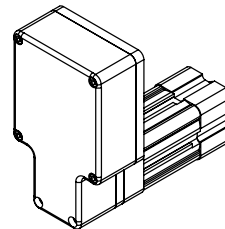

RP

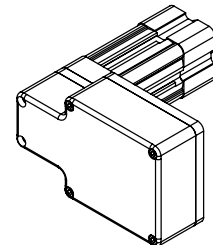

RPR



tolomatic.com/ask
Technical support
before and after
purchase

RSA ST Electric Rod-Style Actuator

tolomatic.com/CAD Download 3D CAD Always use CAD solid model to determine critical dimensions



SIZE: ALL

DIMENSIONS

ST ACTUATOR DIMENSIONS

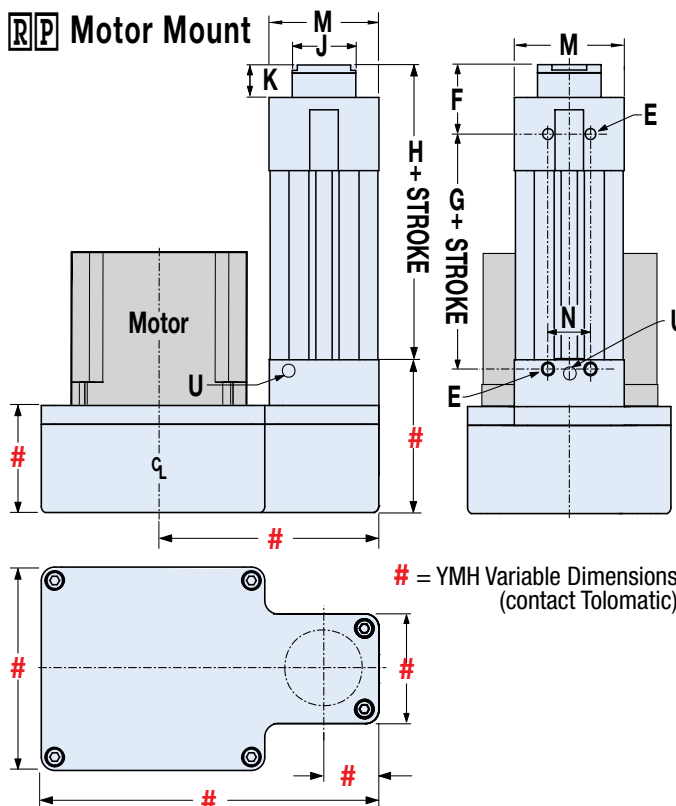
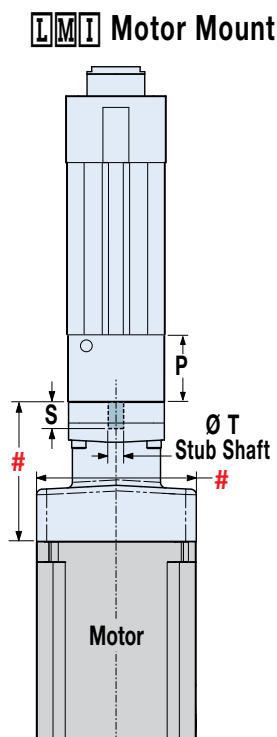
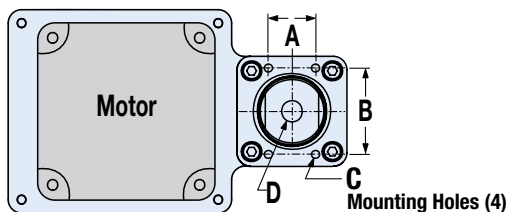

∞NOTE: YM code may change this dimension. Always use configured CAD model to determine critical dimensions

ST ACTUATOR DIMENSIONS

Size							ACME NUT		BALL NUT									
	A	B	C [†] [4x]	D	E [4x]	F	G	H	G	H	J Ø	K	M	N	P	S	T	U
12	0.906	0.391	5-40 \downarrow 0.50	1/4-28 \downarrow 0.75	8-32 \downarrow 0.25	0.81	2.17	2.76	2.17	2.76	0.56	0.31	1.13	0.50	0.72	0.61	0.188	-
16	0.500	1.063	8-32 \downarrow 0.50	5/16-24 \downarrow 0.75	8-32 \downarrow 0.25	1.06	2.13	2.99	2.13	2.99	0.69	0.43	1.38	0.50	0.72	0.61	0.188	-
24	0.875	1.603	10-24 \downarrow 0.79	7/16-20 \downarrow 1.00	1/4-20 \downarrow 0.31	1.11	2.90	3.84	3.36	4.30	1.18	0.43	2.04	0.79	1.42	0.55	0.315	-
32	1.181	1.969	1/4-20 \downarrow 0.71	7/16-20 \downarrow 1.13	5/16-18 \downarrow 0.47	1.43	3.87	5.05	5.05	6.23	1.25	0.50	2.58	0.95	1.79	0.69	0.394	1/16-27 NPT
50	1.969	3.000	5/16-18 \downarrow 1.00	3/4-16 \downarrow 1.50	3/8-16 \downarrow 0.68	1.95	4.78	6.44	5.78	7.44	1.75	0.70	3.71	1.18	2.13	1.36	0.500	1/8-27 NPT
64	1.969	3.500	7/16-14 \downarrow 1.50	3/4-16 \downarrow 1.50	7/16-14 \downarrow 0.88	2.37	6.94	8.90	8.94	10.90	2.25	0.68	4.58	1.97	3.48	1.36	0.750	1/8-27 NPT

Dimensions in inches

Size							ACME NUT		BALL NUT									
	A	B	C [†] [4x]	D	E [4x]	F	G	H	G	H	J Ø	K	M	N	P	S	T	U
12	23.01	9.93	M3x0.5 \downarrow 12.0	M6x1.0 \downarrow 15	M4x0.7 \downarrow 6.4	20.7	55.1	70.1	55.1	70.1	14.2	7.8	28.6	12.7	18.3	15.5	4.78	-
16	12.70	27.00	M4x0.7 \downarrow 8.0	M8x1.25 \downarrow 16	M4x0.7 \downarrow 6.4	26.9	54.2	75.9	54.2	75.9	17.5	10.9	35.0	12.7	18.3	15.5	4.78	-
24	22.23	40.72	M5x0.8 \downarrow 20.0	M10x1.25 \downarrow 25.4	M6x1.0 \downarrow 8.6	28.2	73.7	97.5	85.4	109.2	30.0	10.9	51.8	20.0	36.0	14.0	8.00	-
32	30.00	50.00	M6x1.0 \downarrow 18.0	M16x1.5 \downarrow 26.6	M8x1.25 \downarrow 12.0	36.3	98.4	128.3	128.3	158.2	31.8	12.7	65.5	24.1	45.4	17.5	10.00	1/16-27 NPT
50	50.00	76.20	M8x1.25 \downarrow 25.4	M20x1.5 \downarrow 40	M10x1.5 \downarrow 17.3	49.5	121.5	163.6	146.9	189.0	44.5	17.8	94.1	30.0	54.0	34.5	12.70	1/8-27 NPT
64	50.00	88.90	M12x1.75 \downarrow 38.1	M27x2.0 \downarrow 38.1	M12x1.75 \downarrow 22.2	60.2	176.2	226.1	227.0	276.9	57.2	17.3	116.3	50.0	88.3	34.5	19.05	1/8-27 NPT

Dimensions in millimeters

RSA ST Rod End Options

tolomatic.com/CAD Download 3D CAD Always use CAD solid model to determine critical dimensions



SIZE: ALL

DIMENSIONS

SRE SPHERICAL ROD END

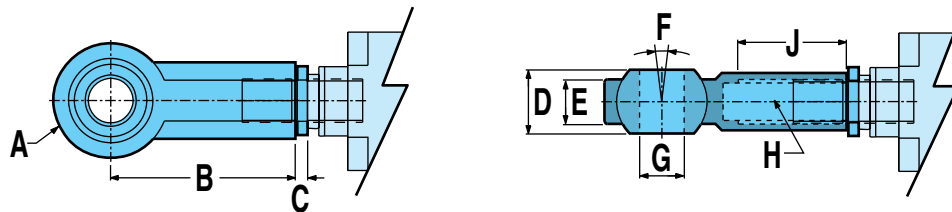

Allows for slight misalignment between the load and the actuator (radial and angular). Uses an industry-standard bearing.

Size		A Ø	B	C	D	E	F	G Ø	H	J
12	in	0.750	1.312	0.10	0.375	0.281	10°	0.250	1/4-28	0.75
	mm	18.00	30.00	2.5	9.00	6.80		6.00	M6x1	12.0
16	in	0.875	1.375	0.10	0.437	0.344		0.312	5/16-24	0.75
	mm	24.00	36.00	2.5	12.00	9.00		8.00	M8x1.25	16.0
24	in	1.125	1.812	0.15	0.560	0.437		0.438	7/16-20	1.06
	mm	28.00	43.00	3.8	14.00	10.50		10.00	M10x1.25	20.0
32	in	1.125	1.812	0.15	0.560	0.437		0.437	7/16-20	1.06
	mm	42.00	64.00	4.8	21.00	15.00		16.00	M16x1.5	28.0
50	in	1.750	2.875	0.19	0.875	0.687		0.750	3/4-16	1.75
	mm	50.00	77.00	4.8	25.00	18.00		20.00	M20x1.5	33.0
64	in	1.750	2.875	0.19	0.875	0.687	0.750	3/4-16	1.75	
	mm	70.00	110.00	6.4	37.00	25.00	30.00	M27x2.0	51.0	

CLV CLEVIS ROD END

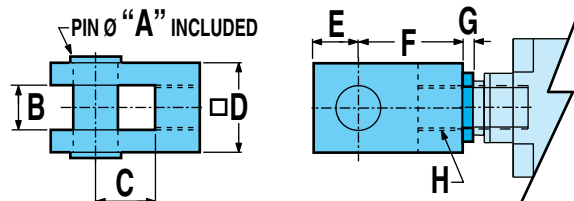

Used with the externally threaded rod end when the actuator has to compensate for misalignment or pivot about an axis.

Size		A Ø	B	C	D	E	F	G	H
12	in	0.250	0.250	0.50	0.50	0.25	0.812	0.10	1/4-28
	mm	6.10 / 6.07	6.01 / 6.14	12.0	12.0	9.5	24.00	2.5	M6x1.0
16	in	0.375	0.375	0.50	0.75	0.38	0.875	0.10	5/16-24
	mm	8.10 / 8.07	6.01 / 6.14	16.0	16.0	13.0	32.00	2.5	M8x1.25
24	in	0.50	0.51	0.75	1.00	0.50	1.375	0.15	7/16-20
	mm	10.0	10.0	20.0	20.0	16.0	40.00	3.8	M10x1.25
32	in	0.50	0.51	0.75	1.00	0.50	1.375	0.15	7/16-20
	mm	16.0	16.0	32.0	32.0	19.0	64.00	4.8	M16x1.5
50	in	0.75	0.75	1.00	1.50	0.75	1.750	0.19	3/4-16
	mm	20.0	20.0	40.0	40.0	25.0	80.00	4.8	M20x1.5
64	in	0.75	0.75	1.00	1.50	0.75	1.750	0.19	3/4-16
	mm	30.0	30.0	54.0	55.0	45.0	110.00	6.4	M27x2.0

KEY TO SYMBOLS

- ▲ Indicates a note of high importance
- ⊗ Indicates incompatibility with option(s) or size(s)
- 📄 Make note of this item

RSA ST Rod End Options

tolomatic.com/CAD Download 3D CAD Always use CAD solid model to determine critical dimensions



SIZE: ALL

DIMENSIONS

MET EXTERNALLY THREADED ROD END



An alternative to the standard internally threaded end.

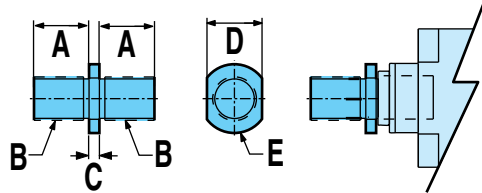

Size		A	B	C	D	E Ø
12	in	0.50	1/4-28	0.10	0.315	0.42
	mm	12.7	M6x1.0	2.5	8.00	10.7
16	in	0.50	5/16-24	0.10	0.375	0.48
	mm	12.7	M8x1.25	2.5	10.00	12.2
24	in	0.87	7/16-20	0.15	0.750	0.97
	mm	22.1	M10x1.25	3.8	19.00	24.6
32	in	0.87	7/16-20	0.15	0.750	0.97
	mm	28.0	M16x1.5	4.8	19.00	24.6
50	in	1.50	3/4-16	0.19	1.250	1.48
	mm	38.1	M-20x1.5	4.8	32.00	37.6
64	in	1.50	3/4-16	0.19	1.250	1.48
	mm	38.1	M27x2	6.4	32.00	38.1

ALC ALIGNMENT COUPLER

INTERNALLY THREADED END

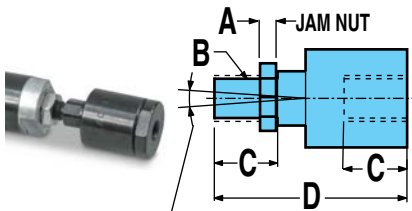

2 SPHERICAL MOTION, 0.0625 (1.6) RADIAL FLOAT

EXTERNALLY THREADED END

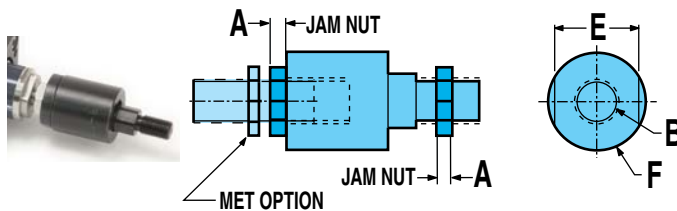

THE ALIGNMENT COUPLER COMES WITH AN INTERNAL THREAD. IF AN EXTERNAL THREAD IS PREFERRED, THE ADDITION OF THE "MET" OPTION IS REQUIRED.

Size		A	B	C	D	E	F
12	in	0.16	1/4-28	0.63	1.88	0.81	0.88
	mm	-	-	-	-	-	-
16	in	0.20	5/16-24	0.63	1.88	0.81	0.88
	mm	-	-	-	-	-	-
24	in	0.25	7/16-20	0.75	2.75	1.13	1.25
	mm	6.4	M10x1.25	24.0	77.0	19.0	30.0
32	in	0.25	7/16-20	0.75	2.75	1.13	1.25
	mm	8.0	M16x1.5	32.0	106.0	30.0	42.0
50	in	0.45	3/4-16	1.13	3.44	1.50	1.75
	mm	10.0	M20x1.5	42.0	122.0	30.0	42.0
64	in	0.45	3/4-16	1.13	3.44	1.50	1.75
	mm	13.5	M27x2.0	54.0	147.0	32.0	55.0

Used in combination with the externally threaded rod end to provide smooth motion and extends actuator life by preventing binding caused by angular or axial misalignment. Not available for use with clevis or trunnion mounts, as they must be rigidly mounted.

If you need external thread, be sure to also order the MET external rod end

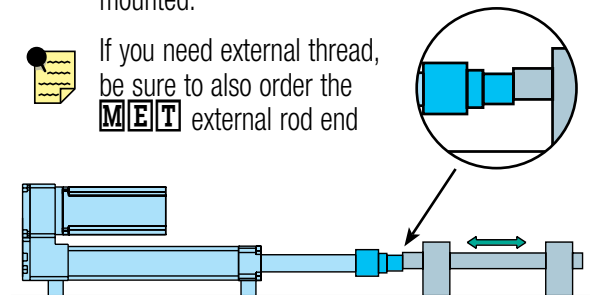

RSA ST Mounting Options

tolomatic.com/CAD Download 3D CAD Always use CAD solid model to determine critical dimensions



SIZE: ALL

DIMENSIONS

FFG FRONT FLANGE MOUNT



Used when a bottom-tapped mount is not an option or where bottom support mechanisms are not feasible.

Flange can be mounted directly to framework or a bulkhead

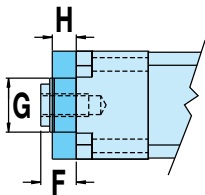
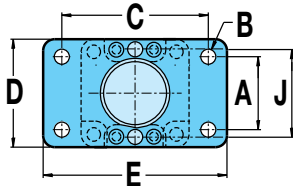

Size		A	B Ø	C	D	E	F	G Ø	H	J
12	in	0.500	0.157	1.500	1.12	2.00	0.31	0.72	0.25	—
	mm	12.70	4.00	38.10	28.5	50.8	7.8	18.3	6.3	—
16	in	0.945	0.18	1.896	1.38	2.39	0.43	0.81	0.37	—
	mm	24.00	4.5	48.16	35.1	60.7	11.0	20.5	9.3	—
24	in	1.430	0.31	2.750	2.00	3.37	0.43	1.34	0.37	—
	mm	32.00	7.2	64.00	47.0	80.0	11.0	34.0	10.0	—
32	in	1.840	0.37	3.375	2.50	4.12	0.50	1.50	0.37	—
	mm	45.00	9.2	90.00	65.0	113.0	12.7	34.0	12.0	—
50	in	2.760	0.43	4.687	3.75	5.50	0.70	1.90	0.62	—
	mm	63.00	12.2	126.00	97.0	153.0	17.7	48.3	16.0	—
64	in	3.320	0.45	5.437	4.50	6.25	0.68	2.40	0.62	—
	mm	84.33	14.2	150.00	111.0	186.0	17.3	61.0	16.0	—

ADDITIONAL FFG MOUNT ORDER CODES

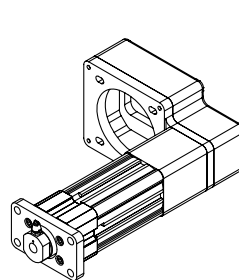

FFG RPR

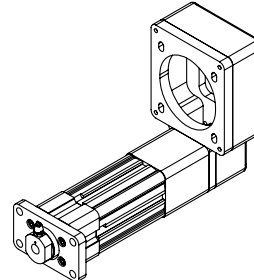

FFG RP

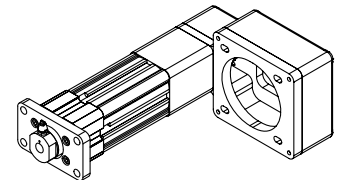

FFG RPL

Note that these configurations all are shown with the tapped mounting holes at the bottom of the actuator (These additional ordering codes are unnecessary if the tapped mounting holes are not used)

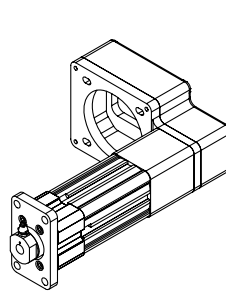

FFGR RPR

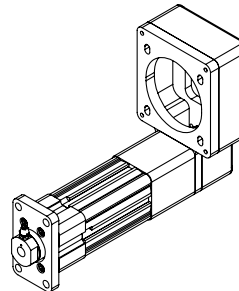

FFGR RP

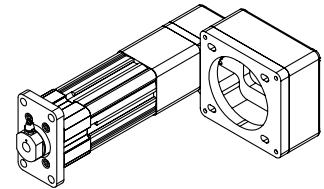

FFGR RPL

RSA ST Mounting Options

tolomatic.com/CAD Download 3D CAD Always use CAD solid model to determine critical dimensions



SIZE: ALL

DIMENSIONS

M P 2 MOUNTING PLATE

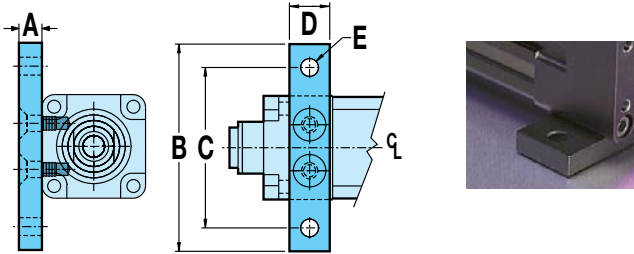

Used for mountings other than flush.

Size		A	B	C	D	E Ø
12 17 FRAME	in	0.50	2.25	1.75	0.40	0.19
	mm	12.7	57.2	44.4	10.2	4.8
12 23 FRAME or YMH option	in	0.63	2.50	2.00	0.40	0.19
	mm	16.0	63.5	50.8	10.2	4.8
16	in	0.63	2.50	2.00	0.40	0.19
	mm	16.0	63.5	50.8	10.2	4.8

Size		A	B	C	D	E Ø
24	in	0.50	3.50	2.75	1.50	0.44
	mm	12.0	78.0	62.0	25.4	6.7
32	in	0.50	4.00	3.25	1.50	0.44
	mm	12.0	104.0	84.0	31.8	8.70
50	in	0.75	5.75	4.75	1.75	0.56
	mm	20.0	144.0	120.0	30.5	11.0
64	in	0.75	6.50	5.50	1.75	0.56
	mm	20.0	180.0	150.0	57.2	12.8

B F G BACK FLANGE MOUNT

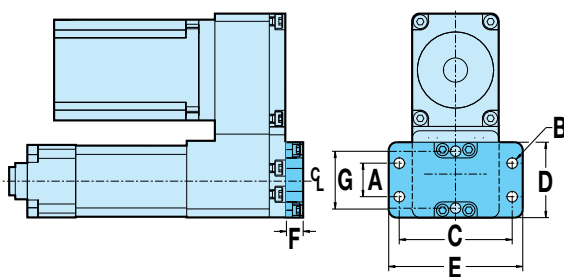

Size		A	B Ø	C	D	E	F	G
12	in	0.500	0.157	1.500	1.12	2.00	0.25	—
	mm	12.70	4.00	38.10	28.5	50.8	6.35	—
16	in	0.945	0.18	1.896	1.38	2.39	0.37	—
	mm	24.00	4.5	48.16	35.1	60.7	9.40	—
24	in	1.430	0.31	2.750	2.00	3.37	0.37	—
	mm	32.00	7.2	64.00	47.0	80.0	9.40	—
32	in	1.840	0.37	3.375	2.50	4.12	0.37	—
	mm	45.00	9.2	90.00	65.0	113.0	9.40	—
50	in	2.760	0.43	4.687	3.75	5.50	0.62	—
	mm	63.00	12.2	126.00	97.0	153.0	15.7	—
64	in	3.320	0.43	5.437	4.50	6.25	0.62	—
	mm	75.00	14.2	150.00	111.0	186.0	15.7	—

Used when a bottom-tapped mount is not an option or where bottom support mechanisms are not feasible. Flange can be mounted directly to framework or a bulkhead

⊗ Not available with LMI (inline) motor mounting

ADDITIONAL BFG MOUNT ORDER CODES

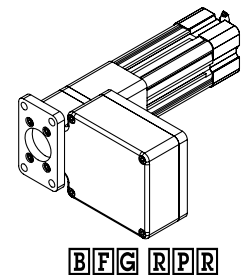
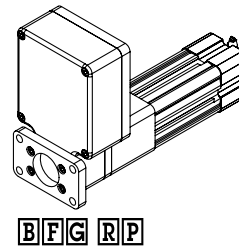
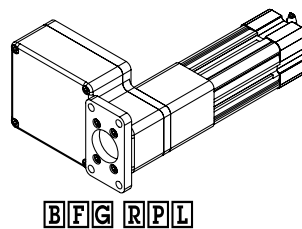

Note that these configurations all are shown with the tapped mounting holes at the bottom of the actuator (These additional ordering codes are unnecessary if the tapped mounting holes are not used)

RSA ST Mounting Options

tolomatic.com/CAD Download 3D CAD Always use CAD solid model to determine critical dimensions



SIZE: ALL

DIMENSIONS

PCS EYE MOUNT & PCD CLEVIS MOUNT



Used when the actuator has to compensate for misalignment or pivot about an axis when free movement is available in the back of the actuator.

⊗ Not available with LMI (inline) motor mounting



Used when the actuator has to compensate for misalignment or pivot about an axis when free movement is available in the back of the actuator.

⊗ Not available with LMI (inline) motor mounting.

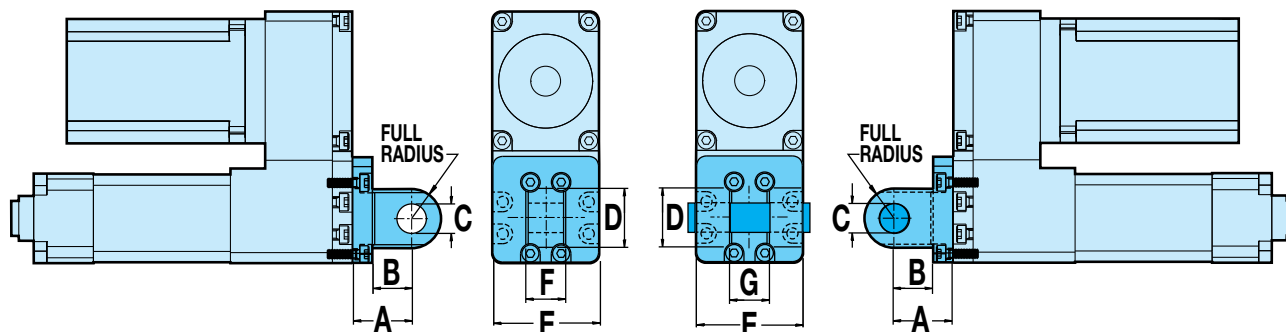

Size		A	B	C Ø	D	E	F	G
12	in	0.750	0.500	0.3761 / 0.3751	0.75	1.34	0.447 / 0.442	0.453 / 0.448
	mm	19.05	12.70	10.018 / 10.000	19.0	34.0	11.35 / 11.22	11.51 / 11.38
16	in	0.750	0.500	0.3761 / 0.3751	0.75	1.34	0.447 / 0.442	0.453 / 0.448
	mm	19.05	12.70	10.018 / 10.000	19.0	34.0	11.35 / 11.22	11.51 / 11.38
24	in	1.062	0.687	0.501 / 0.500	1.00	1.98	0.750 / 0.745	0.755 / 0.751
	mm	22.00	12.00	10.03 / 10.00	20.0	50.2	25.80 / 25.60	26.12 / 26.01
32	in	1.062	0.687	0.501 / 0.500	1.00	2.58	0.750 / 0.745	0.755 / 0.751
	mm	27.00	15.00	12.03 / 12.00	26.0	65.5	31.80 / 31.60	32.12 / 32.01
50	in	1.875	1.375	0.751 / 0.750	1.50	3.60	1.250 / 1.245	1.255 / 1.251
	mm	36.00	20.00	16.03 / 16.00	40.0	91.5	49.80 / 49.60	50.12 / 50.01
64	in	1.875	1.375	0.751 / 0.750	1.50	4.48	1.250 / 1.245	1.255 / 1.251
	mm	44.00	26.00	20.03 / 20.00	40.0	113.7	59.80 / 59.60	60.12 / 60.01

KEY TO SYMBOLS

▲ Indicates a note of high importance

⊗ Indicates incompatibility with option(s) or size(s)

📄 Make note of this item

RSA ST Mounting Options

tolomatic.com/CAD Download 3D CAD Always use CAD solid model to determine critical dimensions



SIZE: ALL

DIMENSIONS

ADDITIONAL PCS and PCD MOUNT ORDER CODES

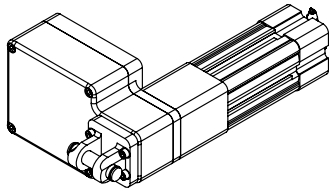

PCD RPL

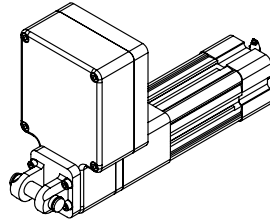

PCD RP

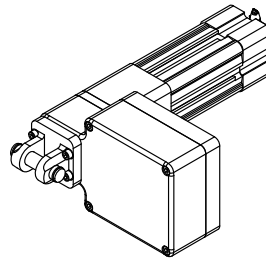

PCD RPR

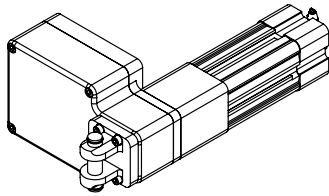

PCDR RPL

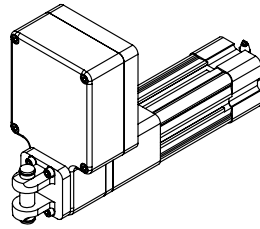

PCDR RP

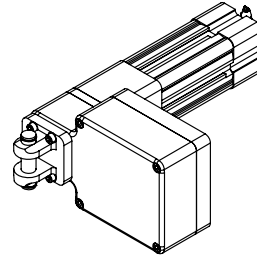

PCDR RPR

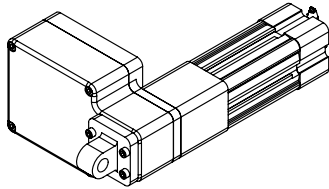

PCS RPL

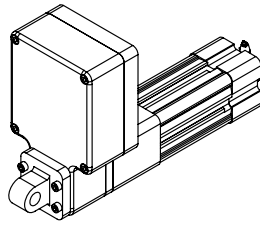

PCS RP

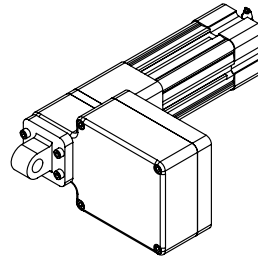

PCS RPR

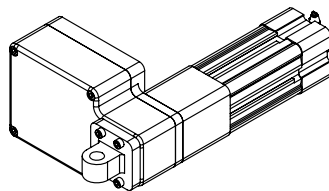

PCSR RPL

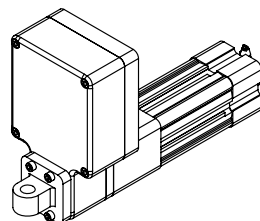

PCSR RP

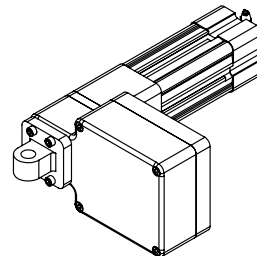

PCSR RPR

Note that these configurations all are shown with the tapped mounting holes at the bottom of the actuator (These additional ordering codes are unnecessary if the tapped mounting holes are not used)

RSA ST Mounting Options

tolomatic.com/CAD Download 3D CAD Always use CAD solid model to determine critical dimensions



SIZE: ALL

DIMENSIONS

TRUNNION MOUNT



Used where space is limited in the rear of the actuator and when pivoting about an axis is required.

⊗ Not available with 12 or 16 size LMI (inline) motor mounting

RSA US standard
(Sizes: 24, 32, 50, 64)

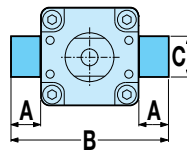

RSM Metric
(+RSA12, RSA16)

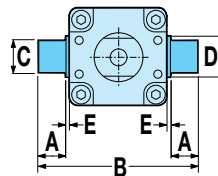

Both RSA US standard
RSM Metric

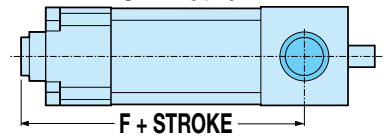

RSA: US standard	Size		A	B	C Ø	D Ø	E	F (LMI)			F (RP)		
								ACME NUT	BALL NUT	ROLLER NUT	ACME NUT	BALL NUT	ROLLER NUT
	12	in	0.38	2.25	0.4374/0.4368	0.562	0.078	NA	NA	NA	3.09	3.09	NA
	16	in	0.38	2.25	0.4374/0.4368	0.562	0.078	NA	NA	NA	3.30	3.30	NA
	24	in	1.04	4.12	0.9999/0.9993	NA	NA	4.46	4.94	6.33	4.30	4.73	6.33
	32	in	1.00	4.58	0.9999/0.9993	NA	NA	6.06	7.24	7.42	5.65	6.83	7.42
	50	in	1.06	5.83	0.9999/0.9993	NA	NA	7.44	8.44	NA	7.14	8.14	NA
	64	in	1.06	6.70	0.9999/0.9993	NA	NA	9.90	11.90	NA	9.80	11.80	NA

RSM: Metric	Size		A	B	C Ø	D Ø	E	F (LMI)			F (RP)		
								ACME NUT	BALL NUT	ROLLER NUT	ACME NUT	BALL NUT	ROLLER NUT
	12	mm	9.5	57.2	11.981/11.999	14.3	2.0	NA	NA	NA	78.5	78.5	NA
	16	mm	9.5	57.2	11.981/11.999	14.3	2.0	NA	NA	NA	83.8	83.8	NA
	24	mm	8.6	75.7	11.96/11.99	18.0	3.3	113.4	125.5	160.8	109.1	120.2	160.8
	32	mm	16.0	107.0	15.95/15.98	25.0	4.74	153.8	183.8	188.5	143.5	173.5	188.5
	50	mm	20.1	150.1	19.95/19.98	30.0	7.9	191.0	214.4	NA	181.3	206.7	NA
	64	mm	24.9	181.9	24.97/24.99	40.0	7.9	251.6	302.4	NA	248.9	299.7	NA

RSA ST Mounting Options

tolomatic.com/CAD Download 3D CAD Always use CAD solid model to determine critical dimensions



SIZE: ALL

DIMENSIONS

✗ FM2 FOOT MOUNTS DISCONTINUED (FOR REFERENCE ONLY)



Used when mounting holes on bottom of actuator are not accessible.

✗ Not available with LMI (inline) motor mounting

✗ Not available with HT option

Size		A	B	C Ø	D	E	F	G
12	in	0.16	0.55	0.15	0.75	1.13	0.77	0.09
	mm	4.1	14.0	3.9	19.1	28.6	19.7	2.3
16	in	0.16	0.55	0.15	0.77	1.34	1.00	0.09
	mm	4.1	14.0	3.9	19.7	34.0	25.4	2.3
24	in	0.37	1.00	0.33	1.19	2.04	1.25	0.12
	mm	7.1	23.9	7.0	29.9	51.8	32.2	3.0
32	in	0.37	1.00	0.41	1.43	2.58	1.75	0.13
	mm	9.5	32.0	9.0	36.3	64.0	45.0	3.2
50	in	0.50	1.25	0.46	1.93	3.70	2.75	0.12
	mm	16.5	41.0	12.0	49.1	96.0	63.0	3.2
64	in	0.50	1.25	0.46	2.32	4.58	3.50	0.12
	mm	19.0	41.0	14.0	59.0	113.0	75.0	3.2

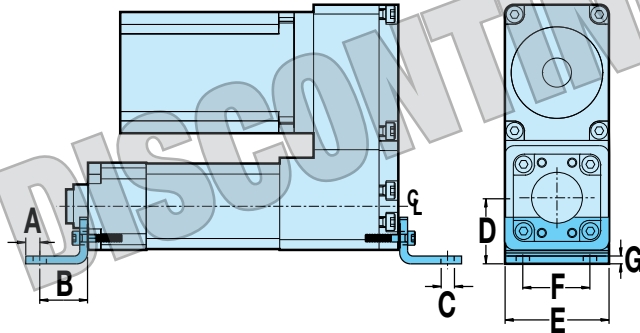

XR OPTIONAL ROD EXTENSION

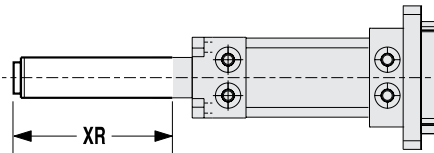

In **vertical applications only**, the thrust rod length can be extended by specifying the rod extension option. This does not increase the working stroke, only the length of the thrust rod.

NOTE: the XR dimension in the configurator string (extension + stroke) should not exceed the maximum stroke of the specified actuator. Consult Tolomatic for extensions greater than the maximum stroke length.

Maximum Stroke Length

Size		All Screws
12	in	12
	mm	305
16	in	18
	mm	457
24	in	24
	mm	610
32	in	36
	mm	914
50	in	48
	mm	1219
64	in	60
	mm	1524

RSA HT Electric Rod-Style Actuator

SIZE: **24, 32, 50, 64** units: **US standard**

SPECIFICATIONS



sizeit.tolomatic.com
for fast, accurate
actuator selection

RSA SIZE	MAX STROKE in	SCREW TYPE	SCREW LEAD turns/in	MAX THRUST* lbf	DYNAMIC LOAD RATING** lbf	LEAD ACCURACY† in/ft	BACKLASH in	SCREW DIAMETER in	BASE ACTUATOR INERTIA lb-in ²	INERTIA PER in OF STROKE lb-in ²	MAXIMUM DYNAMIC FRICTION TORQUE lb-in
24	24	RN04	6.35	1,700	5,577	0.0004	0.0012	0.591	0.086	0.004	5.8
	24	RN05	5.08	1,700	5,577	0.0004	0.0012	0.591	0.087	0.004	4.2
	24	RN10	2.54	1,556	5,577	0.0004	0.0012	0.591	0.092	0.004	6.3
32	36	BZ10	10.00	2,500	N/A	0.0060	0.0080	0.750	0.144	0.009	4.1
	36	BN(L)02	2.00	2,500	3,364	0.0040	0.0150	0.750	0.152	0.010	3.1
	36	BN(L)05	5.00	950	1,624	0.0030	0.0150	0.750	0.145	0.009	3.3
	36	BNM05	5.08	1,792	3,080	0.0040	0.0030	0.787	0.145	0.011	2.5
	36	BNM10	2.54	2,473	4,721	0.0040	0.0030	0.787	0.149	0.012	2.6
	36	BNM20	1.27	2,364	2,560	0.0020	0.0050	0.787	0.165	0.013	2.8
	36	RN04	6.35	4,159	12,761	0.0004	0.0012	0.787	1.166	0.011	8.7
	36	RN05	5.08	3,878	12,761	0.0004	0.0012	0.787	1.167	0.011	9.0
	36	RN10	2.54	4,159	12,761	0.0004	0.0012	0.787	1.177	0.011	10.9
50	48	BZ10	10.00	3,500	N/A	0.0060	0.0080	1.000	0.611	0.028	13.0
	48	BN(L)01	1.00	2,300	2,300	0.0040	0.0150	1.000	0.701	0.035	5.6
	48	BN(L)02	2.00	4,250	5,355	0.0040	0.0150	1.000	0.633	0.030	5.7
	48	BN(L)04	4.00	3,250	5,159	0.0040	0.0150	1.000	0.616	0.028	7.0
	48	BNM05	5.08	2,347	4,035	0.0020	0.0040	0.984	0.614	0.028	8.3
	48	BNM10	2.54	2,471	3,372	0.0020	0.0040	0.984	0.625	0.029	6.7
	48	BNM25	1.02	2,524	2,537	0.0040	0.0050	0.984	0.698	0.035	6.9
	36	RN05	5.08	7,868	16,245	0.0004	0.0012	1.181	1.861	0.058	18.5
	36	RN10	2.54	7,868	16,245	0.0004	0.0012	1.181	1.885	0.059	17.0
64	60	BZ10	10.00	7,000	N/A	0.0060	0.0080	1.500	5.368	0.139	33.1
	60	BN(L)53	0.53	3,500	5,961	0.0040	0.0150	1.500	6.285	0.174	17.6
	60	BN(L)02	2.00	9,050	11,402	0.0040	0.0150	1.500	5.431	0.141	20.8
	60	BN(L)04	4.00	4,250	6,746	0.0040	0.0150	1.500	5.382	0.139	25.0
	60	BNM05	5.08	3,906	6,714	0.0020	0.0040	1.575	5.376	0.139	12.0
	60	BNM10	2.54	5,479	7,476	0.0020	0.0040	1.575	5.406	0.140	34.7
	60	BNM20	1.27	5,105	5,528	0.0020	0.0050	1.575	5.527	0.145	32.6
	60	BNH(L)02	2.00	12,900	16,253	0.0040	0.0020	1.500	5.431	0.141	31.9
	36	RN05	5.08	13,039	23,954	0.0004	0.0012	1.417	5.379	0.118	30.3
	36	RN10	2.54	11,997	23,954	0.0004	0.0012	1.417	5.421	0.119	33.3

SCREW CODE	DESCRIPTION
BN	Ball Nut
BNH	Ball Nut H-series
BNL	Low-Backlash Ball Nut
BNM	Ball Nut Metric
BZ	Bronze Nut
RN	Roller Nut
SN	Solid Nut



Contact Tolomatic for higher accuracy and lower backlash options.

† (L) for low backlash ball screws: backlash = 0.0020" (0.05 mm)

* For SN & BZ screws, maximum continuous dynamic thrust subject to Thrust x Velocity limitation.

** For RN, BN & BNL screws, dynamic load rating reflects 90% reliability for 1 million revolutions.

§ RSA50 & RSA64 extended stroke length 48" (1219 mm) available for roller screws, contact Tolomatic for production time

RSA HT Electric Rod-Style Actuator

sizeit.tolomatic.com
for fast, accurate
actuator selection

SIZE: **24, 32, 50, 64** units: **metric****

SPECIFICATIONS

** RSA metric actuators use the same leadscrew as the RSA inch actuators. Threaded mounting and dowel pin holes are metric.

RSA SIZE	MAX STROKE mm	SCREW TYPE	SCREW LEAD mm/rev	MAX THRUST* N	DYNAMIC LOAD RATING** N	LEAD ACCURACY† mm/300mm	BACKLASH mm	SCREW DIAMETER mm	BASE ACTUATOR INERTIA kg-cm ²	INERTIA PER mm OF STROKE kg-cm ²	MAXIMUM DYNAMIC FRICTION TORQUE N-m
24	609.6	RN04	4.00	7,562	24,808	0.01	0.03	15.0	0.25	0.0004	0.66
	609.6	RN05	5.00	7,562	24,808	0.01	0.03	15.0	0.25	0.0004	0.47
	609.6	RN10	10.00	6,921	24,808	0.01	0.03	15.0	0.27	0.0005	0.71
32	914.4	BZ10	2.54	11,121	N/A	0.15	0.20	19.1	0.42	0.0010	0.46
	914.4	BN(L)02	12.70	11,121	14,964	0.10	0.38	19.1	0.45	0.0011	0.35
	914.4	BN(L)05	5.08	4,226	7,224	0.08	0.38	19.1	0.42	0.0010	0.37
	914.4	BNM05	5.00	7,971	13,701	0.10	0.08	20.0	0.42	0.0013	0.28
	914.4	BNM10	10.00	11,000	21,000	0.10	0.08	20.0	0.44	0.0013	0.29
	914.4	BNM20	20.00	10,516	11,387	0.05	0.13	20.0	0.48	0.0015	0.32
	914.4	RN04	4.00	18,500	56,764	0.01	0.03	20.0	3.41	0.0012	0.98
	914.4	RN05	5.00	17,250	56,764	0.01	0.03	20.0	3.42	0.0012	1.02
	914.4	RN10	10.00	18,500	56,764	0.01	0.03	20.0	3.45	0.0013	1.23
50	1219.2	BZ10	2.54	15,569	N/A	0.15	0.20	25.4	1.79	0.0032	1.47
	1219.2	BN(L)01	25.40	10,231	10,231	0.10	0.38	25.4	2.05	0.0041	0.63
	1219.2	BN(L)02	12.70	18,905	23,820	0.10	0.38	25.4	1.85	0.0034	0.64
	1219.2	BN(L)04	6.35	14,457	22,948	0.10	0.38	25.4	1.81	0.0033	0.79
	1219.2	BNM05	5.00	10,440	17,949	0.05	0.10	25.0	1.80	0.0032	0.94
	1219.2	BNM10	10.00	10,992	14,999	0.05	0.10	25.0	1.83	0.0033	0.76
	1219.2	BNM25	24.90	11,227	11,285	0.10	0.13	25.0	2.04	0.0040	0.78
	914.4	RN05	5.00	34,999	72,261	0.01	0.03	30.0	5.45	0.0066	2.09
	914.4	RN10	10.00	34,999	72,261	0.01	0.03	30.0	5.52	0.0067	1.92
64	1524	BZ10	2.54	31,138	N/A	0.15	0.20	38.1	15.73	0.0160	3.74
	1524	BN(L)53	47.92	15,569	26,516	0.10	0.38	38.1	18.42	0.0201	1.99
	1524	BN(L)02	12.70	40,256	50,719	0.10	0.38	38.1	15.91	0.0163	2.35
	1524	BN(L)04	6.35	18,905	30,008	0.10	0.38	38.1	15.77	0.0161	2.82
	1524	BNM05	5.00	17,375	29,865	0.05	0.10	40.0	15.75	0.0160	1.36
	1524	BNM10	10.00	24,372	33,255	0.05	0.10	40.0	15.84	0.0162	3.92
	1524	BNM20	20.00	22,708	24,590	0.05	0.13	40.0	16.20	0.0167	3.68
	1524	BNH(L)02	12.70	57,382	72,297	0.10	0.05	38.1	15.91	0.0163	3.60
	914.4	RN05	5.00	58,000	106,553	0.01	0.03	36.0	15.76	0.0136	3.42
914.4	RN10	10.00	53,365	106,553	0.01	0.03	36.0	15.88	0.0137	3.76	

SCREW CODE	DESCRIPTION
BN	Ball Nut
BNH	Ball Nut H-series
BNL	Low-Backlash Ball Nut
BNM	Ball Nut Metric
BZ	Bronze Nut
RN	Roller Nut
SN	Solid Nut



Contact Tolomatic for higher accuracy and lower backlash options.
† (L) for low backlash ball screws: backlash = 0.0020" (0.05 mm)

* For SN & BZ screws, maximum continuous dynamic thrust subject to Thrust x Velocity limitation.

** For RN, BN & BNL screws, dynamic load rating reflects 90% reliability for 1 million revolutions.

§ RSA50 & RSA64 extended stroke length 48" (1219 mm) available for roller screws, contact Tolomatic for production time

RSA-HT

RSA HT Electric Rod-Style Actuator

sizeit.tolomatic.com
for fast, accurate
actuator selection

SIZE: 24: CRITICAL SPEED CAPACITIES

SPECIFICATIONS

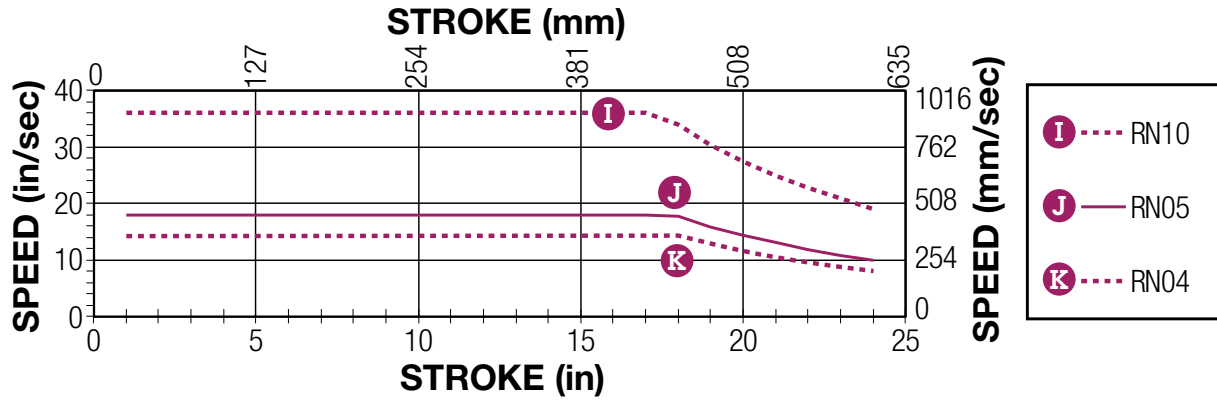

SIZE: 32: CRITICAL SPEED CAPACITIES

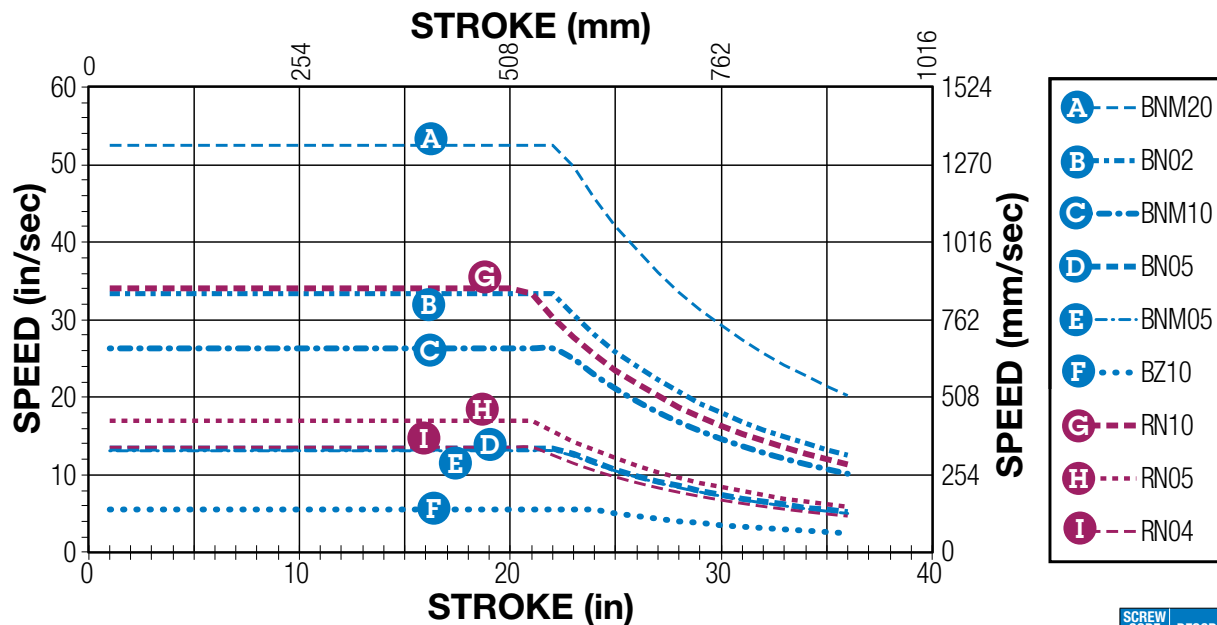

SCREW CODE	DESCRIPTION
BN	Ball Nut
BNH	Ball Nut H-series
BNL	Low-Backlash Ball Nut
BNM	Ball Nut Metric
BZ	Bronze Nut
RN	Roller Nut
SN	Solid Nut

SIZE: 50: CRITICAL SPEED CAPACITIES

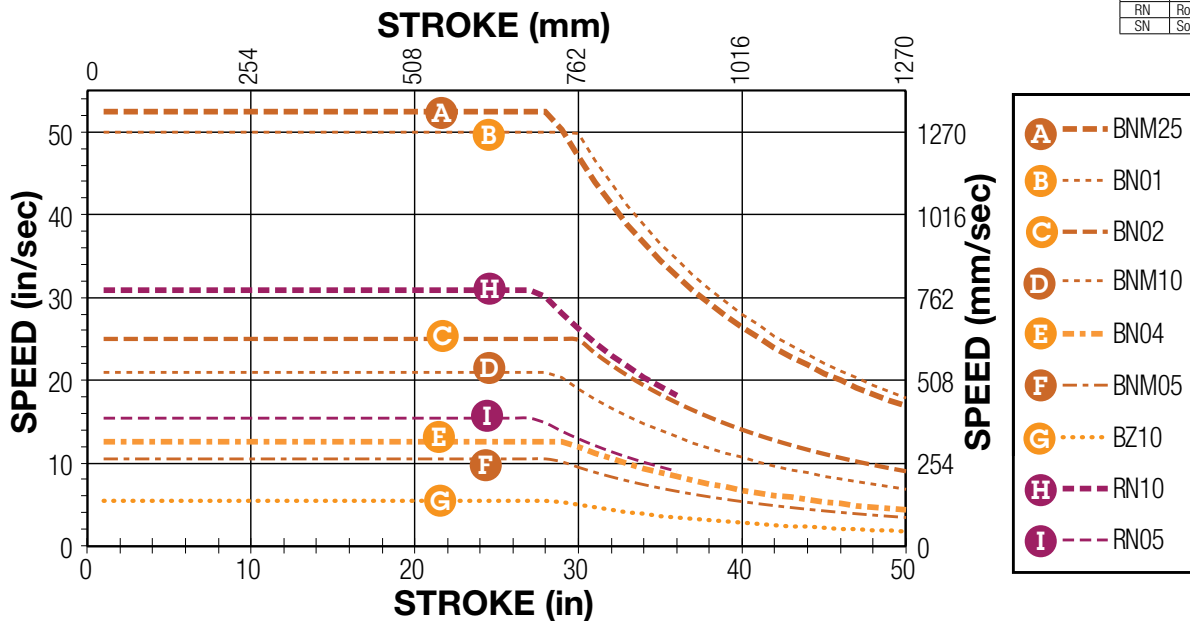

RSA-HT

RSA HT Electric Rod-Style Actuator

sizeit.tolomatic.com
for fast, accurate
actuator selection

SIZE: **64: CRITICAL SPEED CAPACITIES**

SPECIFICATIONS

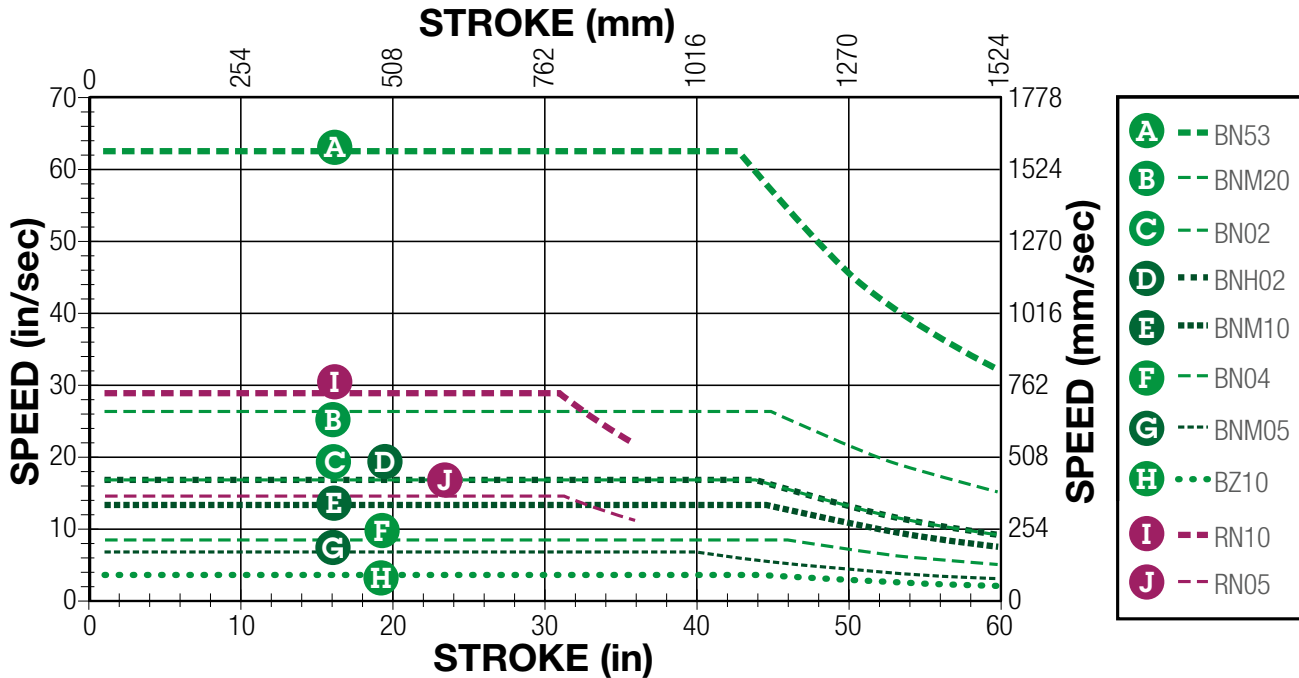

SIZE: **32,50,64 (BZ): PV LIMITS (Bronze Nuts)**

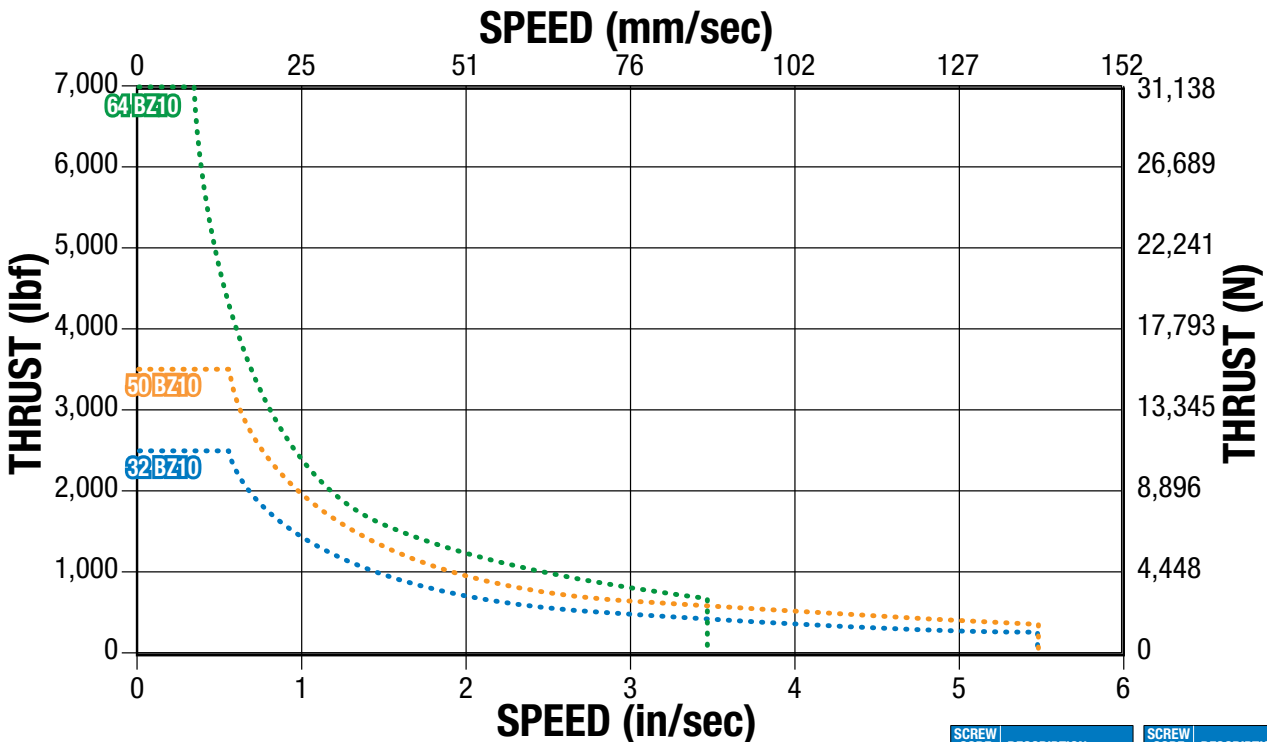

PV LIMITS

PV LIMITS: Any material which carries a sliding load is limited by heat buildup. The factors that affect heat generation rate in an application are the pressure on the nut in pounds per square inch and the surface velocity in feet per minute. The product of these factors provides a measure of the severity of an application.

$$P \times V \leq 0.1$$

$$\left(\frac{\text{Thrust}}{\text{(Max. Thrust Rating)}} \right) \times \left(\frac{\text{Speed}}{\text{(Max. Speed Rating)}} \right) \leq 0.1$$

SCREW CODE	DESCRIPTION	SCREW CODE	DESCRIPTION
BN	Ball Nut	BZ	Bronze Nut
BNH	Ball Nut H-series	RN	Roller Nut
BNL	Low-Backlash Ball Nut	SN	Solid Nut
BNM	Ball Nut Metric		

RSA-HT

RSA HT Electric Rod-Style Actuator

sizeit.tolomatic.com
for fast, accurate
actuator selection

BALL & ROLLER SCREW LIFE GRAPHS

SPECIFICATIONS

SIZE: 24, 32

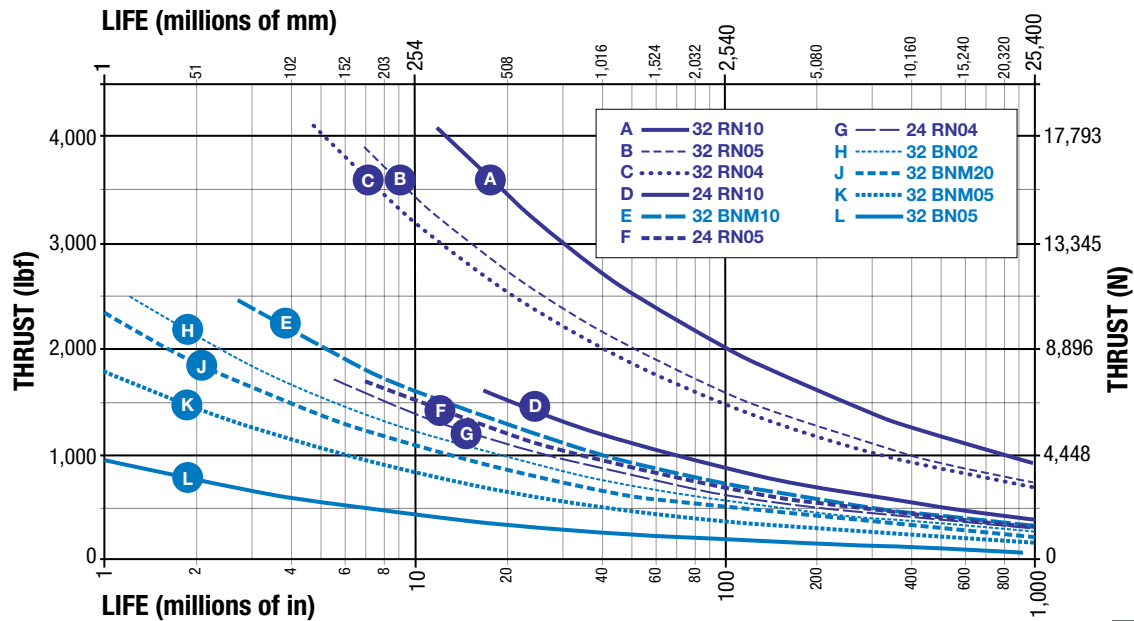

SCREW CODE	DESCRIPTION
BN	Ball Nut
BNH	Ball Nut H-series
BNL	Low-Backlash Ball Nut
BNM	Ball Nut Metric
BZ	Bronze Nut
RN	Roller Nut
SN	Solid Nut

SIZE: 50, 64

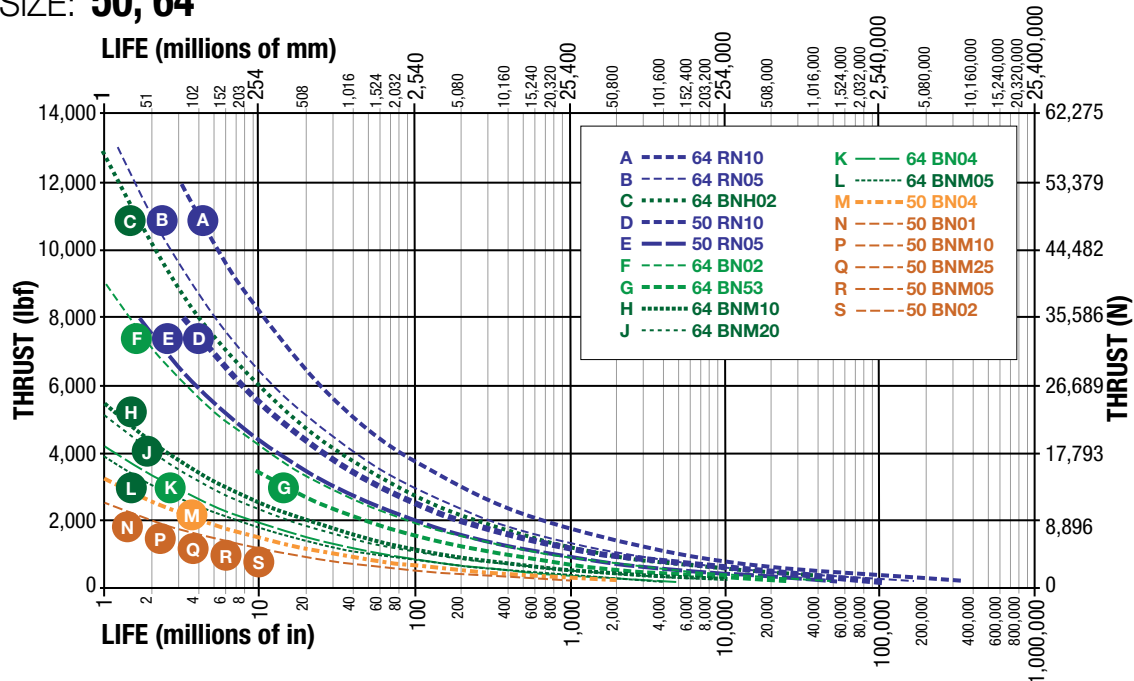

NOTE: The L_{10} expected life of a ball screw linear actuator is expressed as the linear travel distance that 90% of properly maintained ball screw manufactured are expected to meet or exceed. This is not a guarantee and this graph should be used for estimation purposes only.

The underlying formula that defines this value is:

$$L_{10} = \left(\frac{C}{P_e} \right)^3 \cdot \ell =$$

L_{10} Travel life in millions of units (in or mm), where:

C = Dynamic load rating (lbf) or (N)

P_e = Equivalent load (lbf) or (N)

If load is constant across all movements then:

actual load = equivalent load

ℓ = Screw lead (in/rev) (mm/rev)

Use the "Equivalent Load" calculation below, when the load is not constant throughout the entire stroke. In cases where there is only minor variation in loading, use greatest load for life calculations.

$$P_e = \sqrt[3]{\frac{L_1(P_1)^3 + L_2(P_2)^3 + L_3(P_3)^3 + L_n(P_n)^3}{L}}$$

Where:

P_e = Equivalent load (lbf) or (N)

P_n = Each increment at different load (lbf) or (N)

L = Total distanced traveled per cycle (extend + retract stroke)
[$L = L_1 + L_2 + L_3 + L_n$]

L_n = Each increment of stroke at different load (in) or (mm)

RSA HT Electric Rod-Style Actuator

sizeit.tolomatic.com
for fast, accurate
actuator selection

SCREW BUCKLING LOAD

SPECIFICATIONS

SIZE: 24, 32

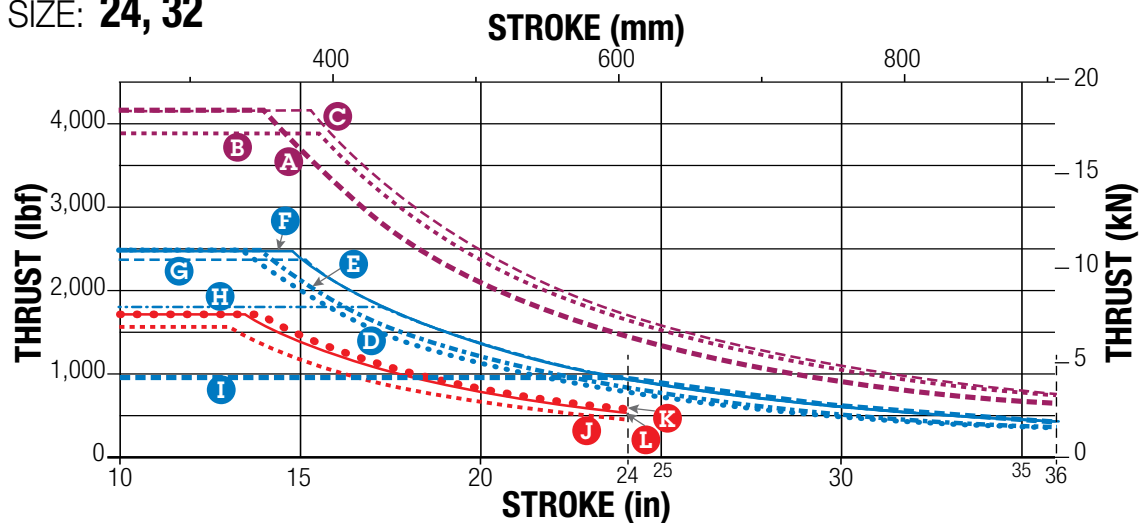

- A --- 32RN10
- B --- 32RN05
- C --- 32RN04
- D --- 32BZ10
- E --- 32BN02
- F --- 32BNM10
- G --- 32BNM20
- H --- 32BNM05
- I --- 32BN05
- J --- 24RN10
- K --- 24RN05
- L --- 24RN04

SIZE: 50

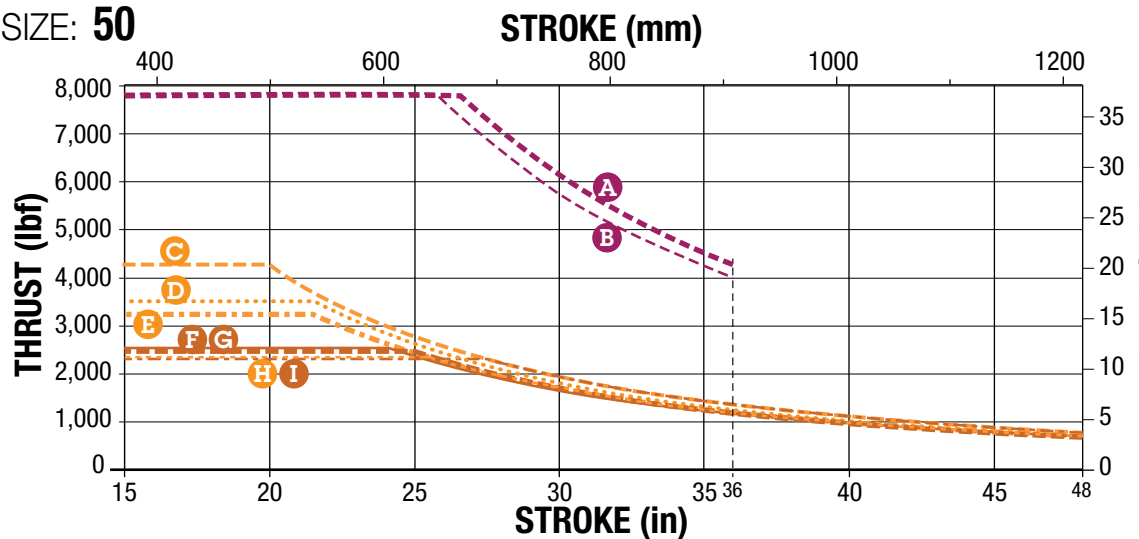

- A --- RN10
- B --- RN05
- C --- BN02
- D --- BZ10
- E --- BN04
- F --- BNM10
- G --- BNM25
- H --- BN01
- I --- BNM05

SIZE: 64

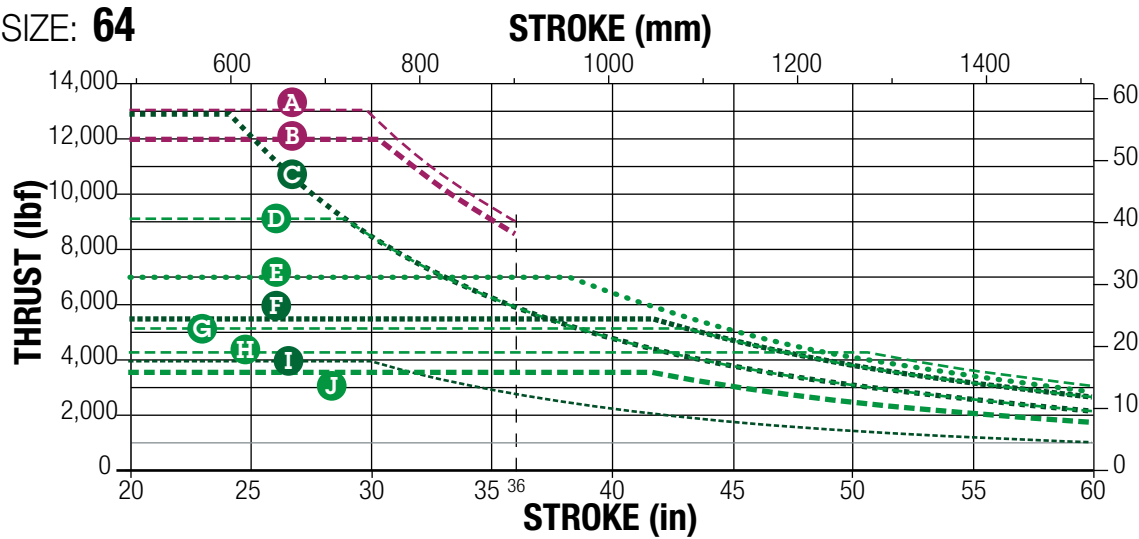

- A --- RN05
- B --- RN10
- C --- BNH02
- D --- BN02
- E --- BZ10
- F --- BNM10
- G --- BNM20
- H --- BN04
- I --- BNM05
- J --- BN53

NOTE: Buckling load limits shown assume perfect alignment. It is recommended to use additional safety margin, particularly in high thrust applications

SCREW CODE	DESCRIPTION
BN	Ball Nut
BNH	Ball Nut H-series
BNL	Low-Backlash Ball Nut
BNM	Ball Nut Metric
BZ	Bronze Nut
RN	Roller Nut
SN	Solid Nut

RSA-HT

RSA HT Electric Rod-Style Actuator

SIZE: 24, 32, 50, 64

SPECIFICATIONS



sizeit.tolomatic.com
for fast, accurate
actuator selection

U.S. Standard

RSA SIZE	WEIGHT					REDUCTION INERTIA		
	BASE	LMI	RP1	RP2	per in of stroke	LMI	RP1	RP2
	lb	lb	lb	lb	lb/in	lb-in ²	lb-in ²	lb-in ²
24	3.8	2.4	2.5	2.2	0.33	0.56	0.38	0.11
32 BN	5.3	5.4	2.9	3.3	0.48	2.35	0.25	0.18
32 RN	10.1	5.2	5.7	6.0	1.18	2.35	1.38	0.66
50 BN	12.6	9.1	5.7	5.9	0.84	6.36	1.47	0.73
50 RN	21.5	11.9	16.3	16.8	0.98	6.36	8.72	4.09
64	39.6	17.7	23.7	24.6	1.42	13.55	13.67	6.95

*Temperature Range (°F): Standard: 40 to 130 Extended: -40 to 140

Metric

RSA SIZE	WEIGHT					REDUCTION INERTIA		
	BASE	LMI	RP1	RP2	per mm of stroke	LMI	RP1	RP2
	kg	kg	kg	kg	g/mm	kg-cm ²	kg-cm ²	kg-cm ²
24	1.73	1.09	1.13	1.00	5.93	1.641	1.113	0.322
32 BN	2.40	2.45	1.32	1.50	8.50	6.886	0.733	0.527
32 RN	4.59	2.36	2.59	2.72	21.01	6.886	4.043	1.934
50 BN	5.73	4.13	2.59	2.68	14.98	18.635	4.307	2.139
50 RN	9.74	5.40	7.39	7.62	17.50	18.635	25.550	11.984
64	17.97	8.03	10.75	11.16	25.30	39.702	40.053	20.364

*Temperature Range (°C): Standard: 4 to 54 Extended -40 to 60

Gasket Kit providing ingress protection against dust and splashing water available upon request



Contact Tolomatic if operation in the extended range is required.

⚠ * Heat generated by the motor and drive should be taken into consideration as well as linear velocity and work cycle time. For applications that require operation outside of the recommended temperature range, contact Tolomatic.

LARGE FRAME MOTORS AND SMALLER SIZE ACTUATORS: Cantilevered motors need to be supported, if subjected to continuous rapid reversing duty and/or under dynamic conditions.

SIDE LOADING CONSIDERATIONS: Rod screw actuators are designed to push guided and supported loads and are not meant for applications that require substantial side loading. Please contact Tolomatic for details regarding side loading capabilities.



tolomatic.com/ask
Technical support
before and after
purchase

RSA HT Electric Rod-Style Actuator



sizeit.tolomatic.com
for fast, accurate
actuator selection

SIZE: **24, 32, 50, 64**

SPECIFICATIONS

RE-LUBRICATION RECOMMENDATION:

RSA-HT Lubrication requirements for electric actuators depend on the motion cycle (velocity, force, duty cycle), type of application, ambient temperature, environmental surrounding and various other factors.

For many general purpose applications, Tolomatic ball screw actuators are typically considered lubricated for life unless otherwise specified, such as those actuator models outfitted with a re-lubrication feature. For roller screw or ball screw actuators outfitted with a re-lubrication feature, Tolomatic recommends to re-lubricate the actuator at least once per year or every 1,000,000 cycles, whichever comes first, to maximize service life. For more demanding applications such as pressing,

high frequency or other highly stressed applications, the re-lubrication interval for these actuators will vary and will need to be more frequent. In these demanding applications, it is recommended to execute at least 5 full stroke moves every 5,000 cycles of operation (or more frequent if possible) to re-distribute the grease within the actuator.

Re-lubricate with Tolomatic Grease into the grease zerk located on the rod end.

	RSA24	RSA32	RSA50	RSA64
Qty.	2.5g + (0.010x §mm)	4.8g + (0.010x §mm)	5.3g + (0.018x §mm)	6.6g + (0.018x §mm)
Qty.	0.09oz + (0.009x §in)	0.17oz + (0.009x §in)	0.19oz + (0.016x §in)	0.23oz + (0.016x §in)

§ = Stroke length (mm or in)



In some applications oil may leak from the grease zerk. In contamination sensitive applications replace grease zerk with plug.

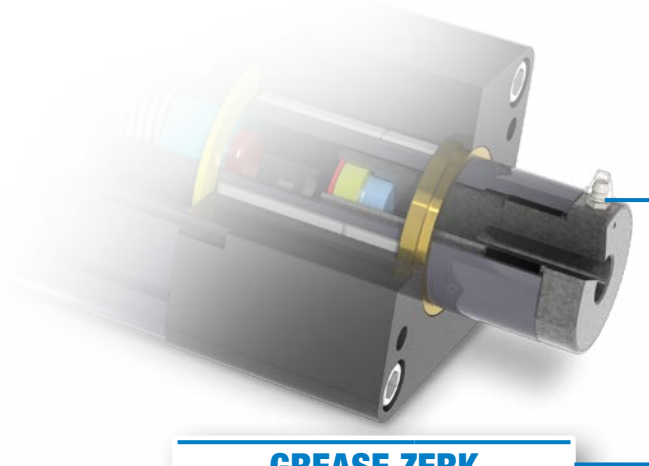

GREASE ZERK

- This relubrication system provides extended screw service life
- Convenient lubrication without disassembly
- Standard with all HT option RSA actuators
- Grease zerk orientation is not pre-defined. Custom orientation can be requested as a product modification

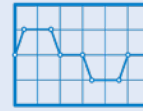

sizeit.tolomatic.com
for fast, accurate
actuator selection



tolomatic.com/ask
Technical support
before and after
purchase

RSA-HT

RSA HT Electric Rod-Style Actuator

tolomatic.com/CAD Download 3D CAD Always use CAD solid model to determine critical dimensions



SIZE: 24,32,50,64

DIMENSIONS

HT ACTUATOR **LMI** Motor Mount

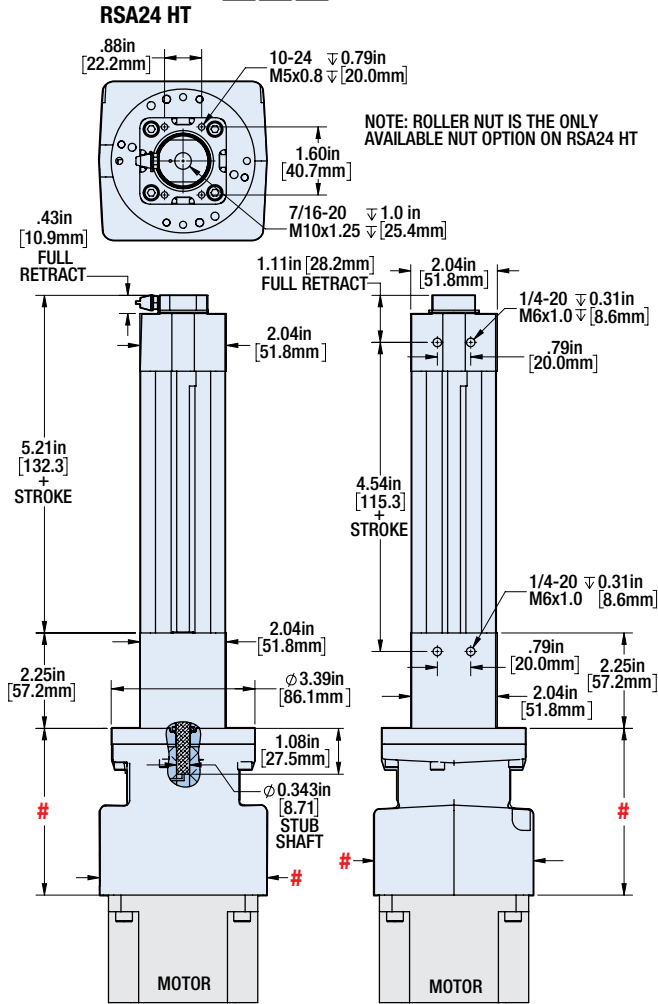

= YMH Variable Dimensions

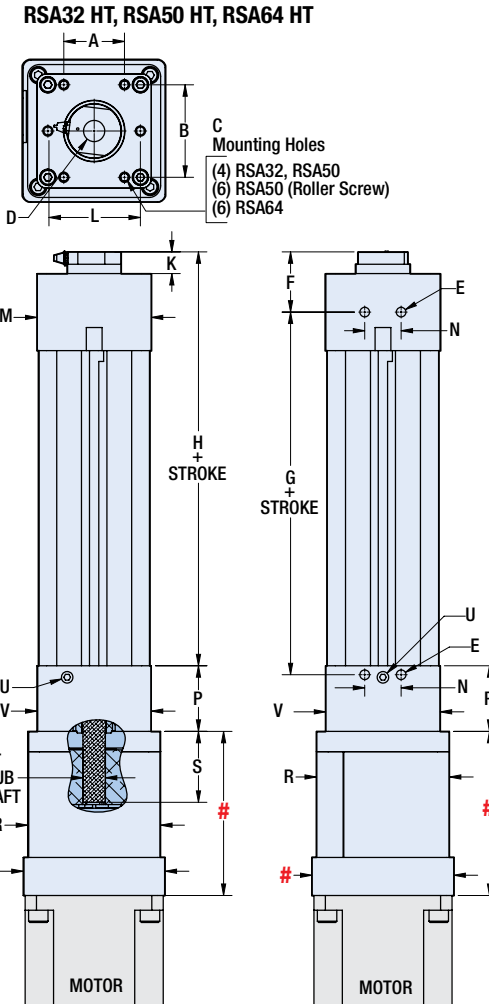

= YMH Variable Dimensions



NOTE: See next page for additional dimensions and RP drawing

		A	B	C	D	E	
RSA32	RN	in	1.18	1.97	1/4-20 ∇ 0.70	7/16-20 ∇ 1.13	5/16-18 ∇ 0.47
		mm	30.0	50.0	M6x1.0 ∇ 18.0	M16x1.5 ∇ 28.6	M8x1.25 ∇ 11.9
	BN	in	1.18	1.97	1/4-20 ∇ 0.70	7/16-20 ∇ 1.13	5/16-18 ∇ 0.47
		mm	30.0	50.0	M6x1.0 ∇ 18.0	M16x1.5 ∇ 28.6	M8x1.25 ∇ 11.9
	BZ	in	1.18	1.97	1/4-20 ∇ 0.70	7/16-20 ∇ 1.13	5/16-18 ∇ 0.47
		mm	30.0	50.0	M6x1.0 ∇ 18.0	M16x1.5 ∇ 28.6	M8x1.25 ∇ 11.9
RSA50	RN	in	1.97	3.00	5/16-18 ∇ 0.47	3/4-16 ∇ 1.50	3/8-16 ∇ 0.75
		mm	50.0	76.2	M8x1.25 ∇ 12.0	M20x1.5 ∇ 38.0	M10x1.5 ∇ 15.0
	BN	in	1.97	3.00	5/16-18 ∇ 0.47	3/4-16 ∇ 1.50	3/8-16 ∇ 0.75
		mm	50.0	76.2	M8x1.25 ∇ 12.0	M20x1.5 ∇ 38.0	M10x1.5 ∇ 15.0
	BZ	in	1.97	3.00	5/16-18 ∇ 0.47	3/4-16 ∇ 1.50	3/8-16 ∇ 0.75
		mm	50.0	76.2	M8x1.25 ∇ 12.0	M20x1.5 ∇ 38.0	M10x1.5 ∇ 15.0
RSA64	RN	in	1.97	3.50	1/2-13 ∇ 0.75	1-1/4-12 ∇ 2.50	7/16-14 ∇ 0.88
		mm	50.0	88.9	M12x1.75 ∇ 18.0	M27x2.0 ∇ 63.5	M12x1.75 ∇ 18.0
	BN	in	1.97	3.50	1/2-13 ∇ 0.75	1-1/4-12 ∇ 2.50	7/16-14 ∇ 0.88
		mm	50.0	88.9	M12x1.75 ∇ 18.0	M27x2.0 ∇ 63.5	M12x1.75 ∇ 18.0
	BZ	in	1.97	3.50	1/2-13 ∇ 0.75	1-1/4-12 ∇ 2.50	7/16-14 ∇ 0.88
		mm	50.0	88.9	M12x1.75 ∇ 18.0	M27x2.0 ∇ 63.5	M12x1.75 ∇ 18.0

RSA HT Electric Rod-Style Actuator

tolomatic.com/CAD Download 3D CAD Always use CAD solid model to determine critical dimensions



SIZE: 24,32,50,64

DIMENSIONS

HT ACTUATOR DIMENSIONS

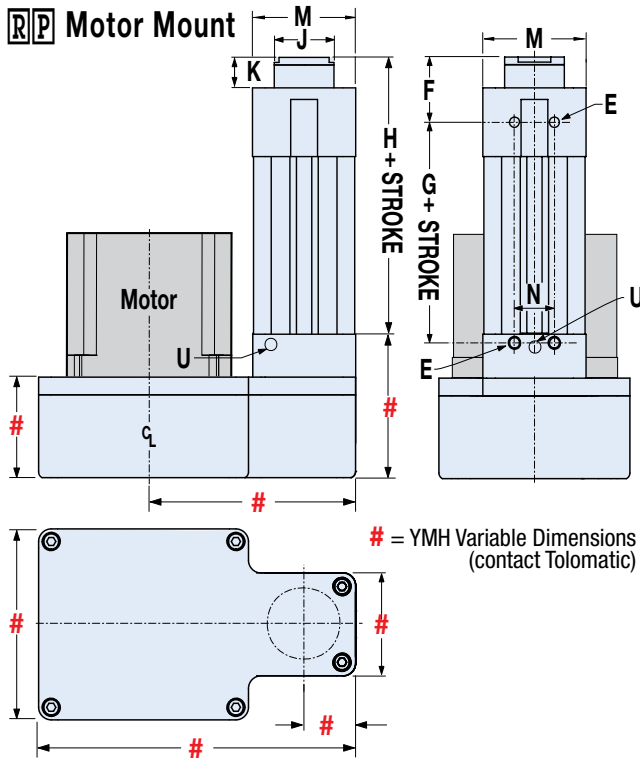
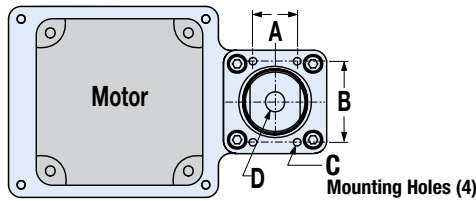

RSA32 HT, RSA50 HT, RSA64 HT

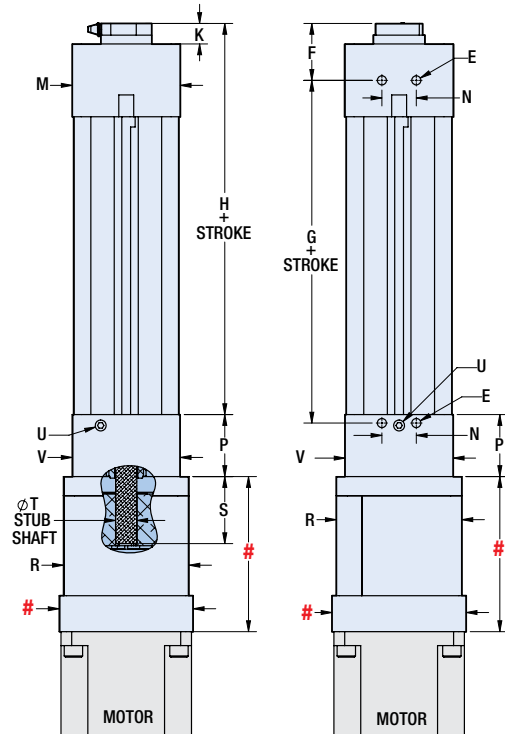
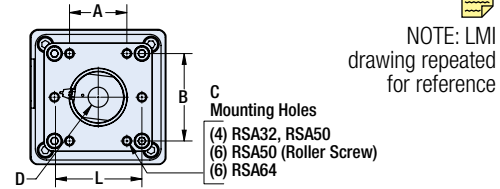

		F	G	H	K	L	M	N	P	R	S	T	U	V	
RSA32	RN	in	1.44	5.92	6.24	0.50	--	2.58	0.95	3.50	3.25	1.70	0.625	1/16-27 NPT	3.25
		mm	36.5	150.4	158.4	12.7	--	65.5	24.1	88.9	82.6	43.2	15.88	1/16-27 NPT	82.6
	BN	in	1.44	5.05	6.24	0.50	--	2.58	0.95	1.79	3.25	1.75	0.530	1/16-27 NPT	2.58
		mm	36.5	128.3	158.4	12.7	--	65.5	24.1	45.4	82.6	44.5	13.46	1/16-27 NPT	65.5
	BZ	in	1.44	3.87	5.06	0.50	--	2.58	0.95	1.79	3.25	1.75	0.530	1/16-27 NPT	2.58
		mm	36.5	96.4	128.4	12.7	--	65.5	24.1	45.4	82.6	44.5	13.46	1/16-27 NPT	65.5
RSA50	RN	in	1.95	7.21	8.41	0.70	3.00	3.71	1.18	3.80	4.31	2.31	0.729	1/8-27 NPT	3.71
		mm	49.5	183.1	213.6	17.8	76.2	94.1	30.0	96.5	109.5	58.7	18.52	1/8-27 NPT	94.2
	BN	in	1.95	5.78	7.44	0.70	--	3.71	1.18	2.13	4.31	2.30	0.730	1/8-27 NPT	3.71
		mm	49.5	146.9	189.0	17.8	--	94.1	30.0	54.0	109.5	58.4	18.54	1/8-27 NPT	94.2
	BZ	in	1.95	4.78	6.44	0.70	--	3.71	1.18	2.13	4.31	2.30	0.730	1/8-27 NPT	3.71
		mm	49.5	121.5	163.6	17.8	--	94.1	30.0	54.0	109.5	58.4	18.54	1/8-27 NPT	94.2
RSA64	RN	in	2.37	7.80	9.29	0.68	3.50	4.58	1.97	4.25	5.60	2.67	0.999	1/8-27 NPT	4.58
		mm	60.1	196.0	235.9	17.3	88.9	116.3	50.0	108.0	142.2	67.9	25.38	1/8-27 NPT	116.3
	BN	in	2.37	10.25	11.74	0.68	3.50	4.58	1.97	4.25	5.60	2.67	0.999	1/8-27 NPT	4.58
		mm	60.1	260.3	298.2	17.3	88.9	116.3	50.0	108.0	142.2	67.9	25.38	1/8-27 NPT	116.3
	BZ	in	2.37	7.80	9.29	0.68	3.50	4.58	1.97	4.25	5.60	2.67	0.999	1/8-27 NPT	4.58
		mm	60.1	198.0	235.9	17.3	88.9	116.3	50.0	108.0	142.2	67.9	25.38	1/8-27 NPT	116.3

NOTE: See previous page for additional dimensions

See page 18 for additional RP mounting codes

RSA HT Rod End Options

tolomatic.com/CAD Download 3D CAD Always use CAD solid model to determine critical dimensions



SIZE: 24, 32, 50, 64

DIMENSIONS

SRE SPHERICAL ROD END

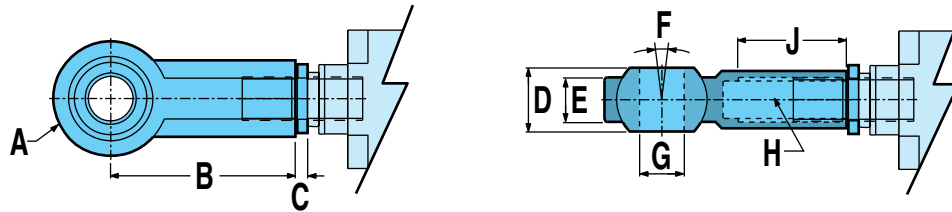

Allows for slight misalignment between the load and the actuator (radial and angular). Uses an industry-standard bearing.

Size		A Ø	B	C	D	E	F	G Ø	H	J
24	in	1.125	1.812	0.15	0.560	0.437	10°	0.438	7/16-20	1.06
	mm	28.00	43.00	3.8	14.00	10.50		10.00	M10x1.25	20.0
32	in	1.125	1.812	0.15	0.560	0.437		0.437	7/16-20	1.06
	mm	42.00	64.00	4.8	21.00	15.00		16.00	M16x1.5	28.0
50	in	1.750	2.875	0.19	0.875	0.687		0.750	3/4-16	1.75
	mm	50.00	77.00	4.8	25.00	18.00		20.00	M20x1.5	33.0
64	in	2.750	4.125	0.19	1.375	1.000		1.00	1-1/4-12	2.13
	mm	70.00	110.00	6.4	37.00	25.00		30.00	M27x2.0	51.0

CLV CLEVIS ROD END

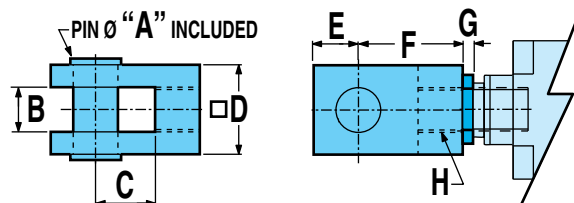

Used with the externally threaded rod end when the actuator has to compensate for misalignment or pivot about an axis.

Size		A Ø	B	C	D	E	F	G	H
24	in	0.50	0.51	0.75	1.00	0.50	1.375	0.15	7/16-20
	mm	10.0	10.0	20.0	20.0	16.0	40.00	3.8	M10x1.25
32	in	0.50	0.51	0.75	1.00	0.50	1.375	0.15	7/16-20
	mm	16.0	16.0	32.0	32.0	19.0	64.00	4.8	M16x1.5
50	in	0.75	0.75	1.00	1.50	0.75	1.750	0.19	3/4-16
	mm	20.0	20.0	40.0	40.0	25.0	80.00	4.8	M20x1.5
64	in	1.375	2.03	1.75	4.03	1.38	3.750	0.19	1-1/4-12
	mm	30.0	30.0	54.0	55.0	45.0	110.00	6.4	M27x2.0

KEY TO SYMBOLS

- ▲ Indicates a note of high importance
- ⊗ Indicates incompatibility with option(s) or size(s)
- 📄 Make note of this item

RSA HT Rod End Options

tolomatic.com/CAD Download 3D CAD Always use CAD solid model to determine critical dimensions



SIZE: 24, 32, 50, 64

DIMENSIONS

MET EXTERNALLY THREADED ROD END



An alternative to the standard internally threaded end.

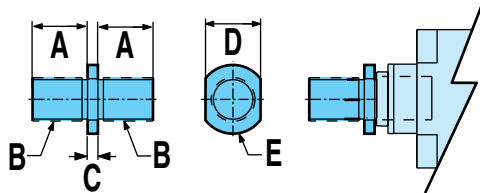

Size		A	B	C	D	E Ø
24	in	0.87	7/16-20	0.15	0.750	0.97
	mm	22.1	M10x1.25	3.8	19.00	24.6
32	in	0.87	7/16-20	0.15	0.750	0.97
	mm	28.0	M16x1.5	4.8	19.00	24.6
50	in	1.50	3/4-16	0.19	1.250	1.48
	mm	38.1	M-20x1.5	4.8	32.00	37.6
64	in	2.13	1-1/4-12	0.19	1.313	1.60
	mm	50.8	M27x2	6.4	32.00	38.1

ALC ALIGNMENT COUPLER

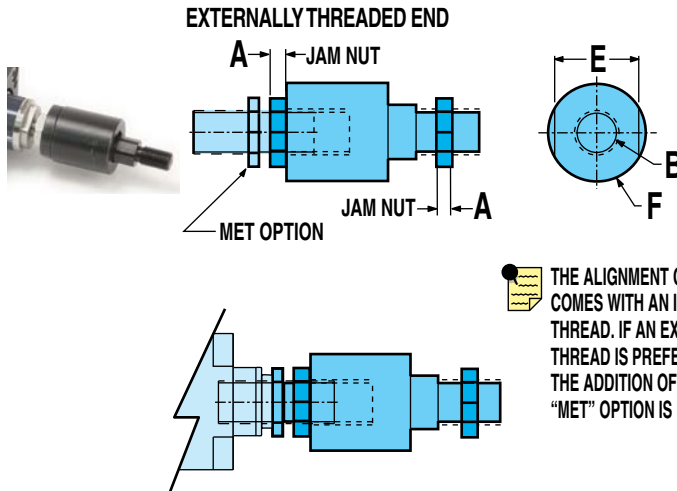
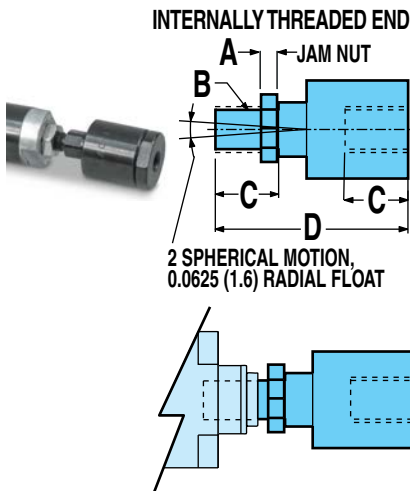

Size		A	B	C	D	E	F
24	in	0.25	7/16-20	0.75	2.75	1.13	1.25
	mm	6.4	M10x1.25	24.0	77.0	19.0	30.0
32	in	0.25	7/16-20	0.75	2.75	1.13	1.25
	mm	8.0	M16x1.5	32.0	106.0	30.0	42.0
50	in	0.45	3/4-16	1.13	3.44	1.50	1.75
	mm	10.0	M20x1.5	42.0	122.0	30.0	42.0
64	in	0.50	1-1/4-12	1.63	4.56	2.25	2.50
	mm	13.5	M27x2.0	54.0	147.0	32.0	55.0

Used in combination with the externally threaded rod end to provide smooth motion and extends actuator life by preventing binding caused by angular or axial misalignment. Not available for use with clevis or trunnion mounts, as they must be rigidly mounted.

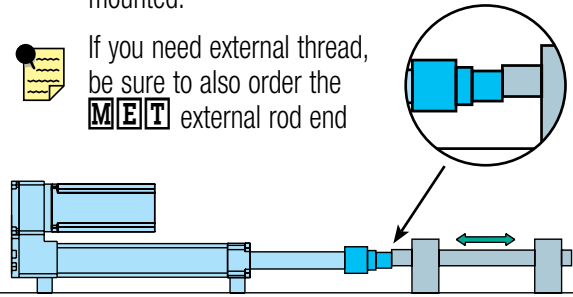

RSA-HT

RSA HT Mounting Options

tolomatic.com/CAD Download 3D CAD Always use CAD solid model to determine critical dimensions



SIZE: 24, 32, 50, 64

DIMENSIONS

FFG FRONT FLANGE MOUNT



Used when a bottom-tapped mount is not an option or where bottom support mechanisms are not feasible.

Flange can be mounted directly to framework or a bulkhead

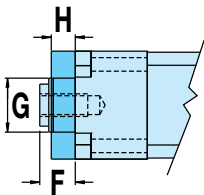
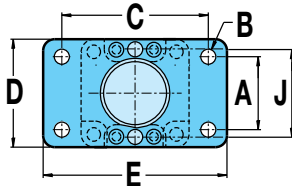

Size		A	B Ø	C	D	E	F	G Ø	H	J
24	in	1.430	0.31	2.750	2.00	3.37	0.80	1.34	0.37	–
	mm	32.00	7.2	64.00	47.0	80.0	20.4	34.0	10.0	–
32	in	1.840	0.37	3.375	2.50	4.12	0.87	1.50	0.37	–
	mm	45.00	9.2	90.00	65.0	113.0	22.1	34.0	12.0	–
50	in	2.760	0.43	4.687	3.75	5.50	1.32	1.90	0.62	–
	mm	63.00	12.2	126.00	97.0	153.0	33.5	48.3	16.0	–
64	in	3.320	0.58	8.000	4.50	9.00	1.48	2.40	0.80	3.50
	mm	84.33	14.7	203.2	114.3	228.6	37.6	61.0	20.3	88.9



See page 22 for additional FFG mount codes

M P 2 MOUNTING PLATE

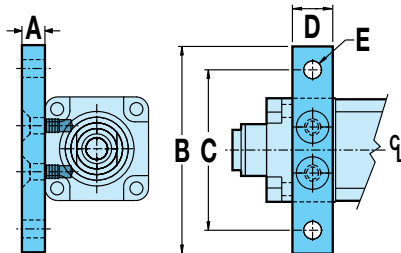

Used for mountings other than flush.

Size		A	B	C	D	E Ø
24	in	0.50	3.50	2.75	1.50	0.44
	mm	12.0	78.0	62.0	25.4	6.7
32 BN	in	0.50	4.00	3.25	1.50	0.44
	mm	12.0	104.0	84.0	31.8	8.7
32 RN	in	0.50	4.00	3.25	1.50	0.44
	mm	12.0	104.0	84.0	31.8	8.7
50 BN	in	0.75	5.75	4.75	1.75	0.56
	mm	20.0	144.0	120.0	30.5	11.0
50 RN	in	1.25	5.75	4.75	1.75	0.56
	mm	31.8	146.1	120.0	44.5	11.0
64	in	1.25	6.50	5.50	1.75	0.56
	mm	31.8	180.0	150.0	44.5	12.8

KEY TO SYMBOLS

- Indicates a note of high importance
- Indicates incompatibility with option(s) or size(s)
- Make note of this item

RSA HT Mounting Options

tolomatic.com/CAD Download 3D CAD Always use CAD solid model to determine critical dimensions



SIZE: 24, 32, 50, 64

DIMENSIONS

T R R TRUNNION MOUNT



Used where space is limited in the rear of the actuator and when pivoting about an axis is required.

RSA US standard (Sizes: 24, 32, 50, 64)

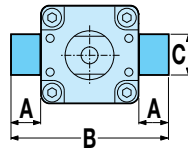

Both RSA US standard RSM Metric

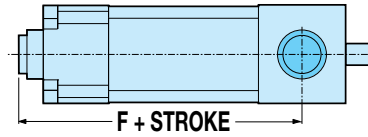

RSA: US standard	Size	A	B	C Ø	D Ø	E	F (LMI)			F (RP)		
							ACME NUT	BALL NUT	ROLLER NUT	ACME NUT	BALL NUT	ROLLER NUT
	24 in	1.04	4.12	0.9999/0.9993	NA	NA	4.46	4.94	6.33	4.30	4.73	6.33
	32 in	1.00	4.58	0.9999/0.9993	NA	NA	6.06	7.24	7.42	5.65	6.83	7.42
	50 in	1.06	5.83	0.9999/0.9993	NA	NA	7.44	8.44	9.07	7.14	8.14	9.07
	64 in	1.25	7.92	0.9999/0.9993	1.50	0.42	10.29	12.74	10.29	10.29	12.74	10.29

RSM: Metric	Size	A	B	C Ø	D Ø	E	F (LMI)			F (RP)		
							ACME NUT	BALL NUT	ROLLER NUT	ACME NUT	BALL NUT	ROLLER NUT
	24 mm	8.6	75.7	11.96/11.99	18.0	3.3	113.4	125.5	160.8	109.1	120.2	160.8
	32 mm	16.0	107.0	15.95/15.98	25.0	4.74	153.8	183.8	188.5	143.5	173.5	188.5
	50 mm	20.1	150.1	19.95/19.98	30.0	7.9	191.0	214.4	230.3	181.3	206.7	230.3
	64 mm	24.9	181.9	24.97/24.99	40.0	7.9	261.3	323.6	261.3	261.3	323.6	261.3

B F G BACK FLANGE MOUNT

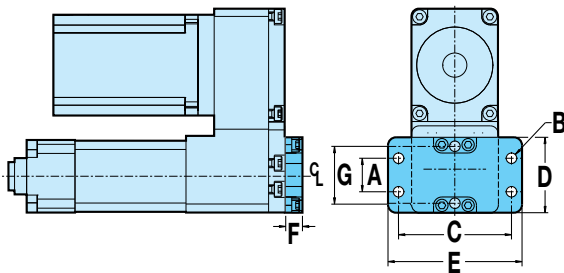

Used when a bottom-tapped mount is not an option or where bottom support mechanisms are not feasible. Flange can be mounted directly to framework or a bulkhead

⊗ Not available with LMI (inline) motor mounting

Size		A	B Ø	C	D	E	F	G
24	in	1.430	0.31	2.750	2.00	3.37	0.37	—
	mm	32.00	7.2	64.00	47.0	80.0	9.40	—
32	in	1.840	0.37	3.375	2.50	4.12	0.37	—
	mm	45.00	9.2	90.00	65.0	113.0	9.40	—
32 RN	in	1.840	0.37	4.000	2.50	4.75	0.37	—
	mm	45.00	9.2	101.60	65.0	120.7	9.40	—
50	in	2.760	0.43	4.687	3.75	5.50	0.62	—
	mm	63.00	12.2	126.00	97.0	153.0	15.7	—
50 RN	in	2.760	0.43	7.000	3.75	8.00	0.62	3.00
	mm	63.00	12.2	177.80	97.0	203.2	15.7	76.2
64	in	3.320	0.58	8.000	4.50	9.00	0.62	3.50
	mm	75.00	14.7	203.2	114.3	228.6	15.7	88.9



See page 22 for additional BFG mount codes

RSA HT Mounting Options

tolomatic.com/CAD Download 3D CAD Always use CAD solid model to determine critical dimensions



SIZE: 24, 32, 50, 64

DIMENSIONS

PCS EYE MOUNT & PCD CLEVIS MOUNT



Used when the actuator has to compensate for misalignment or pivot about an axis when free movement is available in the back of the actuator.

✘ Not available with LMI (inline) motor mounting



Used when the actuator has to compensate for misalignment or pivot about an axis when free movement is available in the back of the actuator.

✘ Not available with LMI (inline) motor mounting.

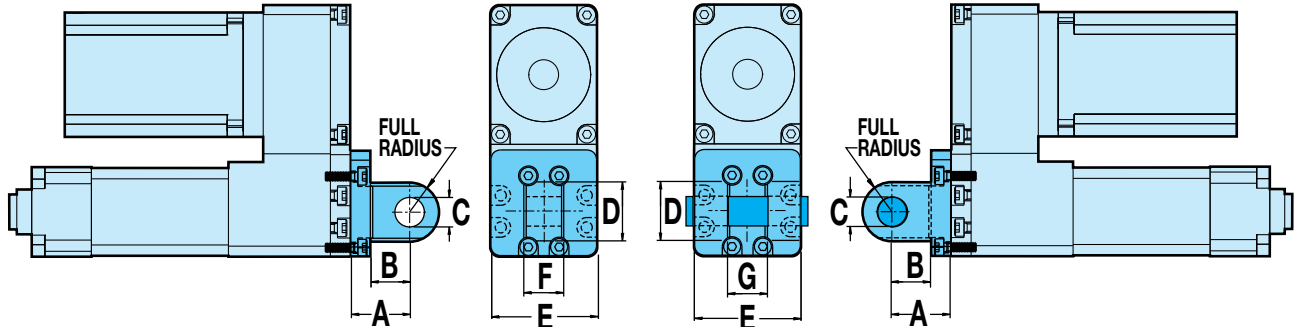

Size		A	B	C Ø	D	E	F	G
24	in	1.062	0.687	0.501 / 0.500	1.00	1.98	0.750 / 0.745	0.755 / 0.751
	mm	22.00	12.00	10.03 / 10.00	20.0	50.2	25.80 / 25.60	26.12 / 26.01
32	in	1.062	0.687	0.501 / 0.500	1.00	2.58	0.750 / 0.745	0.755 / 0.751
	mm	27.00	15.00	12.03 / 12.00	26.0	65.5	31.80 / 31.60	32.12 / 32.01
50	in	1.875	1.375	0.751 / 0.750	1.50	3.60	1.250 / 1.245	1.255 / 1.251
	mm	36.00	20.00	16.03 / 16.00	40.0	91.5	49.80 / 49.60	50.12 / 50.01
64	in	2.335	1.535	1.003 / 1.002	2.00	4.48	1.500 / 1.495	1.505 / 1.501
	mm	59.31	38.99	28.03 / 28.00	50.8	113.7	39.90 / 39.80	40.10 / 40.00



See page 25 for additional PCS and PCD mount codes

KEY TO SYMBOLS

- ▲ Indicates a note of high importance
- ✘ Indicates incompatibility with option(s) or size(s)
- 📄 Make note of this item

RSA HT Mounting Options

tolomatic.com/CAD Download 3D CAD Always use CAD solid model to determine critical dimensions



SIZE: 24, 32, 50, 64

DIMENSIONS

XR OPTIONAL ROD EXTENSION

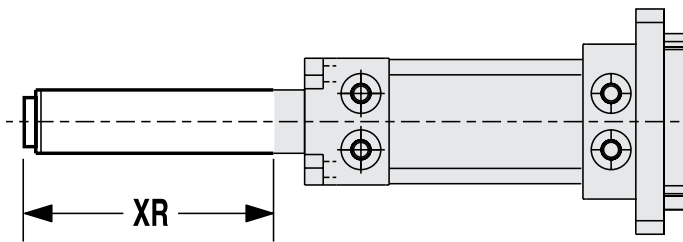

Maximum Stroke Length

Size	All Screws	
24	in	24
	mm	609.6
32	in	36
	mm	914.4
50	in	48
	mm	1219.2
64	in	60
	mm	1524

In **vertical applications only**, the thrust rod length can be extended by specifying the rod extension option. This does not increase the working stroke, only the length of the thrust rod.

NOTE: the XR dimension in the configurator string (extension + stroke) should not exceed the maximum stroke of the specified actuator. Consult Tolomatic for extensions greater than the maximum stroke length.

Z12 ZERK ORIENTATION

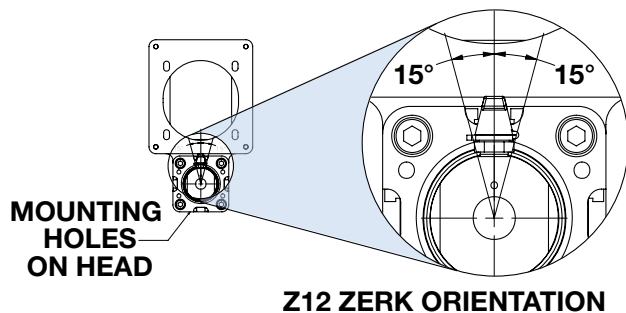

The orientation of the zerk is unspecified unless the Z12 ordering code included in the configuration string

RSA-HT

RSA Electric Rod-Style Actuators

SWITCHES









RSA & GSA products offer a wide range of sensing choices. There are 12 switch choices: reed, solid state PNP (sourcing) or solid state NPN (sinking); in normally open or normally closed; with flying leads or quick-disconnect.

Commonly used for end-of-stroke positioning, these switches allow installation anywhere along the entire actuator length. The internal magnet is a standard feature. Switches can be installed in the field at any time.

Switches are used to send digital signals to PLC (programmable logic controller), TTL, CMOS circuit or other controller device. Switches contain reverse polarity protection. Solid state QD cables are shielded; shield should be terminated at flying lead end.

All switches are CE rated and are RoHS compliant. Switches feature bright red or yellow LED signal indicators; solid state switches also have green LED power indicators.



	Order Code	Lead	Switching Logic	Power LED	Signal LED	Operating Voltage	**Power Rating (Watts)	Switching Current (mA max.)	Current Consumption	Voltage Drop	Leakage Current	Temp. Range	Shock / Vibration
REED	R Y	5m	SPST Normally Open	—	Red	5 - 240 AC/DC	**10.0	100mA	—	3.0 V max.	—	14 to 158°F [-10 to 70°C]	50 G / 9 G
	R K	QD*											
	N Y	5m	SPST Normally Closed	—	Yellow	5 - 110 AC/DC							
	N K	QD*											
SOLID STATE	T Y	5m	PNP (Sourcing) Normally Open	Green	Yellow	10 - 30 VDC	**3.0	100mA	20 mA @ 24V	2.0 V max.	0.05 mA max.		
	T K	QD*											
	K Y	5m	NPN (Sinking) Normally Open	Green	Red								
	K K	QD*											
	P Y	5m	PNP (Sourcing) Normally Closed	Green	Yellow								
	P K	QD*											
	H Y	5m	NPN (Sinking) Normally Closed	Green	Red								
	H K	QD*											

*QD = Quick-disconnect Enclosure classification IEC 529 IP67 (NEMA 6)

CABLES: Robotic grade, oil resistant polyurethane jacket, PVC insulation

⚠️ **WARNING: Do not exceed power rating (Watt = Voltage x Amperage). Permanent damage to sensor will occur.

SWITCH INSTALLATION



Place switch bracket into one of the four slots that run the length of the extruded tube. Note that there is a cutout on the actuator head (RSA) or tube (GSA) to allow insertion of the bracket. Insert the switch with the word "Tolomatic" facing up and slide it under the bracket. Position the bracket with the switch to the exact location desired, then lock them securely into place by tightening both set screws on the bracket.

RSA Electric Rod-Style Actuators

SWITCHES

WIRING DIAGRAMS

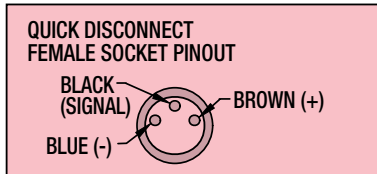
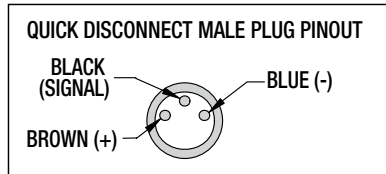
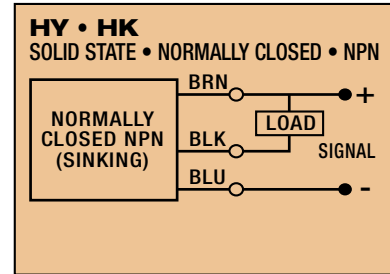
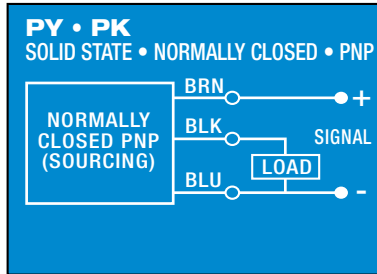
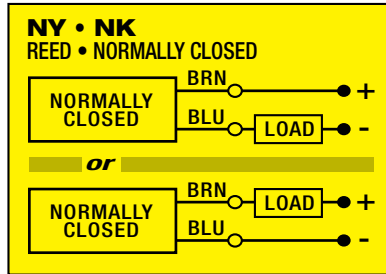
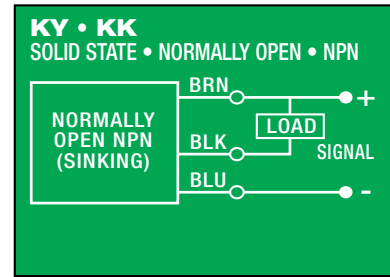
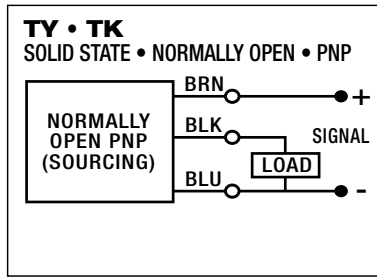
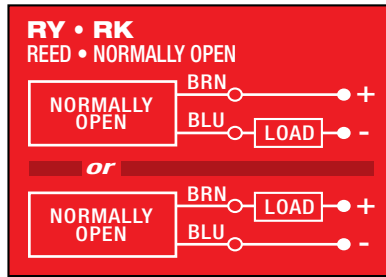

SWITCH DIMENSIONS

_ Y - direct connect

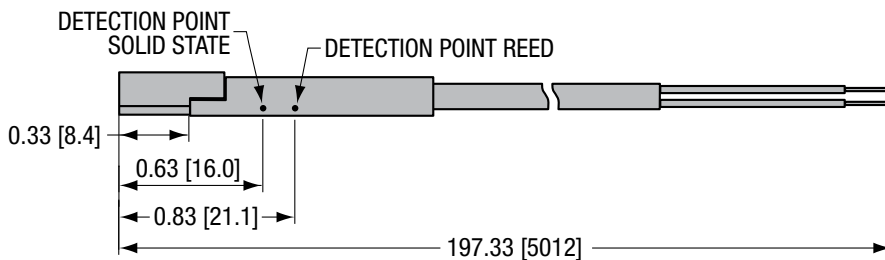

_ K - QD (Quick-disconnect) switch

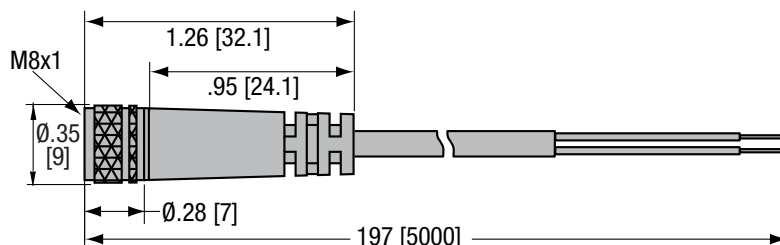
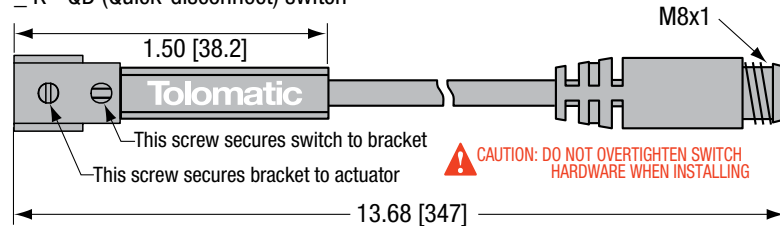

Dimensions shown in inches [dimensions in brackets millimeters]

MOUNTING DIMENSIONS

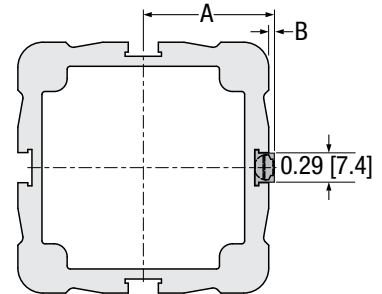

Size	A		B	
	in	mm	in	mm
12	0.68	17.2	0.13	3.3
16	0.77	19.6	0.11	2.9
24	1.06	26.9	0.06	1.5
32	1.31	33.2		
50	1.87	47.5		
64	2.31	58.6		

RSA Electric Rod-Style Actuators

Application Data Worksheet

USE THE TOLOMATIC SIZING AND SELECTION SOFTWARE AVAILABLE ON-LINE AT www.tolomatic.com or call Tolomatic at 1-800-328-2174. We will provide any assistance needed to determine the proper actuator for the job.

ACTUATOR ORIENTATION

- Horizontal Vertical-Motor End Up Angled Vertical-Motor End Down

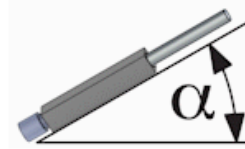

Angle: _____ degrees

ACTUATOR REQUIREMENTS

- Stroke Length: _____ inches millimeters
No. of Cycles: _____ per minute per hour
Actuator to Hold Position: required not required
If Hold Required: after move during power loss
Motor: Third Party Motor Tolomatic Motor

APPLICATION ENVIRONMENT

- Ambient Temperature: _____ °F °C
Actuator Environment Description and Ingress Protection Requirements:

MOTION & FORCES

Extend

- Move Distance: _____ in mm
Move Time: _____ seconds
Max. Speed: _____ in/s mm/s
Dwell Time After Move: _____ seconds

Retract

- Move Distance: _____ in mm
Move Time: _____ seconds
Max. Speed: _____ in/s mm/s
Dwell Time After Move: _____ seconds

Force

- Force: _____ lb_f N
Force Direction: Toward Away
Direction of Applied Force: F_x F_y F_z
Center of Applied Force:
D_x: _____ in mm
D_y: _____ in mm
D_z: _____ in mm
Assign to Moves: Extend Retract

tolomatic.com/ask
Technical support
before and after
purchase



sizeit.tolomatic.com
for fast, accurate
actuator selection

RSA Electric Rod-Style Actuators

Selection Guidelines

1 ESTABLISH MOTION PROFILE

Using the application stroke length, desired cycle time, loads and forces, establish the motion profile details including linear velocity and thrust in each of its segments.

2 SELECT ACTUATOR TYPE

If side (radial) loads are present, select GSA.

3 SELECT ACTUATOR SIZE AND SCREW TYPE

Based on the required velocities and thrust select an actuator size and type and lead of screw drive.

4 VERIFY CRITICAL SPEED OF THE SCREW

Verify that the application's peak linear velocity does not exceed the critical speed value for the size and lead of the screw selected.

5 VERIFY AXIAL BUCKLING STRENGTH OF THE SCREW

Verify that the peak thrust does not exceed the critical buckling force for the size of the screw selected.

6 COMPARE APPLICATION'S PEAK PARAMETERS TO PEAK CAPACITY (PEAK REGION) OF SELECTED ACTUATOR (ROLLER SCREW)

When a roller screw is selected, calculate the application's required peak thrust and peak velocity and compare to the graphs. The selection must satisfy the application's peak requirements.

7 CALCULATE LUBRICATION INTERVAL (ROLLER SCREW)

When a roller screw is selected, calculate the recommended lubrication interval. See page RSA_33 and parts sheets for complete lubrication information for the RSA24, RSA32, RSA50 and RSA64 HT option.



The above guidelines are for reference only. Use Tolomatic online sizing software for best results.

8 TEMPERATURE CONSIDERATIONS

If the application's ambient temperature lies outside of the allowed range [roller screw: 50° to 122°F (10° to 50°C), all others 40° to 130°F (4° to 54°C)], contact the factory. Note that in aggressive applications where roller screw is used, outside temperature of the actuator's body can approach 180°F (82°C), and adequate clearance to avoid overheating of other system components should be allowed.

9 ESTABLISH TOTAL TORQUE REQUIREMENTS

Calculate total system inertia, the peak and the RMS torque required from the motor to overcome internal friction, external forces and accelerate/decelerate the load.

10 SELECT A MOTOR AND A CONTROLLER

Use the obtained total torque value to select a motor and a reduction device (if required). Verify that the peak torque value is below the motor's peak torque curve, and that the continuous torque value is below the motor's continuous torque curve. Verify the minimum torque margin (15%). Verify the inertia match. Select a controller.

11 SELECT A MOTOR-ACTUATOR CONFIGURATION AND SENSORS IF REQUIRED

Select an inline or a reverse-parallel motor configuration. Select mounting and rod end options. Select position sensors (if required). 12 sensor choices include: reed, solid state PNP or NPN, all in normally open or normally closed, with flying leads or quick-disconnect couplers.

12 SELECT ROD END OPTIONS AND MOUNTING OPTIONS

Rod end options include: CLV clevis rod end, SRE spherical rod end, MET externally threaded rod end, ALC alignment coupler, XR rod extension. Mounting options include: TRN trunnion mount, FFG front flange mount, MP2 mounting plates, PCD clevis mount, PCS eye mount, BFG back flange mount.

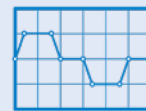

sizeit.tolomatic.com
for fast, accurate
actuator selection



tolomatic.com/ask
Technical support
before and after
purchase

RSA ACTUATOR MOUNTING REPLACEMENT KITS

Code	Size	12		16		24		32		50		64ST		64HT	
		Description	U.S.	Metric	U.S.	Metric	U.S.	Metric	U.S.	Metric	U.S.	Metric	U.S.	Metric	U.S.
For all motor mounts															
FFG	Front Flange Mount	1107-9013	2107-9013	1112-9013	2112-9013	1124-9022	2124-9032	1132-9022	2132-9042	1150-9022	2150-9042	1164-9022	2164-9022	1164-9484	2164-9484
MP2	Mounting Plate	1107-9015	2107-9015	1112-9014	2112-9014	1124-9023	2124-9033	1132-9023	2132-9043	1150-9023	2150-9043	1164-9023	2164-9023	1164-9375	2164-9375
		1112-9014*	2112-9014*	*Mounting Plate with 23 frame motor or YMH Option (for RSA12 size only)											
For RP motor mounting only															
BFG	Back Flange Mount	1107-9014	2107-9014	1112-9025	2112-9025	1124-9022	2124-9032	1132-9022	2132-9042	1150-9022	2150-9042	1164-9022	2164-9022	1164-9484	2164-9484
PCS	Eye Mount	1107-9016	2107-9016	1107-9016	2107-9016	1124-9024	2124-9034	1132-9024	2132-9044	1150-9024	2150-9044	1164-9024	2164-9024	1164-9344	2164-9344
PCD	Clevis Mount	1107-9017	2107-9017	1107-9017	2107-9017	1124-9025	2124-9035	1132-9025	2132-9045	1150-9025	2150-9045	1164-9025	2164-9025	1164-9345	2164-9345

RSA ROD END REPLACEMENT KITS

U.S. MODELS

Code	Size	12	16	24ST	24HT	32ST	32HT	50ST	50HT	64ST	64HT
CLV	Clevis End	1107-9021	1112-9020	1124-9029	1124-9396	1124-9029	1124-9396	1150-9029	1150-9396	1150-9029	1164-9386
SRE	Spherical Rod Eye	1107-9020	1112-9019	1124-9028	1124-9397	1124-9028	1124-9397	1150-9028	1150-9397	1150-9028	1164-9028
MET	External Threaded	1107-1073	1112-1058	1124-1057	1124-1815	1124-1057	1124-1815	1150-1057	1150-1815	1150-1057	1164-1035
ALC*	Alignment Coupler	1107-1076	1112-1061	1124-9004	1124-9004	1124-9004	1124-9004	1150-9009	1150-9009	1150-9009	1164-9385

METRIC MODELS

Code	Size	12	16	24ST	24HT	32ST	32HT	50ST	50HT	64ST	64HT
CLV	Clevis End	2107-9021	2112-9020	2124-9039	2124-9396	2132-9049	2132-9396	2150-9049	2150-9396	2164-9029	2164-9386
SRE	Spherical Rod Eye	2107-9020	2112-9019	2124-9038	2124-9397	2132-9048	2132-9397	2150-9048	2150-9397	2164-9028	2164-9387
MET	External Threaded	2107-1073	2112-1058	2124-1067	2124-1815	2132-1057	2132-1815	2150-1057	2150-1815	2164-1057	2164-1546
ALC*	Alignment Coupler	NA	NA	2124-1070	2132-1060	2132-1060	2132-1060	2150-1060	2150-1060	2164-1060	2164-1060

*NOTE: Alignment coupler is internally threaded, if external thread is desired order MET also

NA = Not Available

RSA SWITCHES

To order switch kit use configuration code for switch preceded by SW and actuator code.

EXAMPLE: **SWR****SA****24****KK**

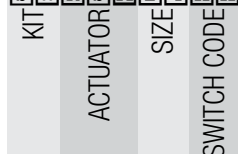

The example is for Solid State NPN, Normally Open Switch with Quick-disconnect couplers. Each switch kit is complete with Bracket, Set Screw, Switch and mating QD cable. Note that the bracket/switch size is common and may be used on any size RSA.

NOTE: Refer to parts sheets to replace switches on actuators manufactured before 5-10-2010.

Code	Lead	Normally	Sensor Type
R Y	5m (197 in)	Open	Reed
R K	Quick-disconnect		
N Y	5m (197 in)	Closed	Reed
N K	Quick-disconnect		
T Y	5m (197 in)	Open	Solid State PNP
T K	Quick-disconnect		
K Y	5m (197 in)	Open	Solid State NPN
K K	Quick-disconnect		
P Y	5m (197 in)	Closed	Solid State PNP
P K	Quick-disconnect		
H Y	5m (197 in)	Closed	Solid State NPN
H K	Quick-disconnect		

RSA Reverse-Parallel Tensioning Tool Kit	24ST	24HT / 32 all	50 all & 64 all
order by part number	1124-9430	1132-9430	1150-9430

RSA ST & HT Electric Rod-Style Actuator

ORDERING

ACTUATOR RSA 50 BNL02 SK35 RPL ST1 FFG XR6 ALC MET KK2 YM **OPTIONS**

MODEL & MOUNTING
RSA Rod-Style Screw-Drive Actuator

SIZE
12, 16, 24, 32, 50, 64

NUT/SCREW		
SIZE	CODE	CODE NUMBER
12	SN	01,02,05
	BZ	10
	BN, BNL	08
16	SN	01,02,05
	BZ	10
	BN, BNL	08
24	SN	02,04,08
	BZ	10
	BN, BNL	02,05
	BNM	05,10
	RN	04,05,10
32	BZ	10
	BN, BNL	02,05
	BNM	05,10,20
	RN	04,05,10
50	BZ	10
	BN, BNL	01,02,04
	BNM	05,10,25
64	RN	05,10
	BZ	10
	BN, BNL	02,04,53
	BNM	05,10,20
	BNH	02
RN	05,10	

STROKE LENGTH
SK ___ Enter desired stroke length in decimal inches

SM† ___ (Metric Mounting)
Enter desired stroke length in millimeters

† The metric version provides metric tapped rod end, actuator mounting and dowel pins

NOTE: Actuator mounting threads and mounting fasteners will be either inch or metric; depending on how stroke length is indicated SK=inch mounting

SM= metric mounting

MAXIMUM STROKE

SIZE	BN, BZ, SN		RN	
	in	mm	in	mm
12	12	304.8	12	304.8
16	18	457.2	18	457.2
24	24	609.6	24	609.6
32	36	914.4	36	914.4
50	48	1,219.2	36 ^S	914.4 ^S
64	60	1,524.0	36 ^S	914.4 ^S

MOTOR MOUNTING

LMI In-line motor mount

RP1 1:1 ratio, reverse parallel motor mount

RPL1 1:1 ratio, reverse parallel motor mount, left or right see page 18 for details

RPR1 1:1 ratio, reverse parallel motor mount, left or right see page 18 for details

RP2 2:1 ratio, reverse parallel motor mount

RPL2 2:1 ratio, reverse parallel motor mount, left or right see page 18 for details

RPR2 2:1 ratio, reverse parallel motor mount, left or right see page 18 for details

⊗ RP2 not available on 12 or 16 size

RP BELT TENSIONING

TEN Belt tensioning tool for RP motor mounting

STANDARD OR HIGH TORQUE

ST1 Standard RS Actuator

HT* High Torque Option
*requires keyed motor

⊗ HT not available on 12 or 16 size
NOTE: RN always requires HT option

TRUNNION MOUNT

TRR Trunnion mount

⊗ Not available on 12 or 16 size with LMI motor mount

📄 NOTE: Trunnion mount is not available for field retrofit, contact Tolomatic for details

ACTUATOR MOUNTING

For all motor mounts:

FFG Front Flange Mount

FFGR Front Flange Mount rotated 90° (see pg. 22)

MP2 Mounting Plates (2 required)

For RP motor mounting only:

PCD Clevis Mount

PCDR Clevis Mount rotated 90° (see pg. 25)

PCS Eye Mount

PCSR Eye Mount rotated 90° (see pg. 25)

BFG Back Flange Mount

^S RSA50 & RSA64 extended stroke length 48" (1219 mm) available for roller screws, contact Tolomatic for production time

ROD EXTENSION

XR ___ Enter desired rod extension in inches (SK) or millimeters (SM)

(Same unit of measure as stroke length is required)

⚠ For vertical applications only.

📄 NOTE: The XR extension + stroke should not exceed the max. stroke of the specified actuator. (See MAX. STROKE table) Consult Tolomatic for extensions greater than the max. stroke length.

ROD END

Internally threaded rod end is standard

CLV Clevis Rod End

SRE Spherical Rod End

MET Externally Threaded Rod End

ALC Alignment Coupler Rod End*

Z12 Grease Zerk at 12 O'clock position (see page 43)

📄 *NOTE: Alignment coupler is internally threaded, if external thread is desired order MET also

ENVIRONMENTAL PROTECTION

Standard actuator IP54

IP67 Basic ingress protection (RSA32, 50, 64 only)

LUB Grease, Food/Drug

SWITCHES

TYPE	LOGIC	NORMALLY	QUICK-DISCONNECT	CODE	QUANTITY	LEAD LENGTH
REED	SPST	Open	no	RY	After code enter quantity desired	5 meters (16.4 feet)
		Closed	yes	RK		
SOLID STATE	PNP	Open	no	TY		
		Closed	yes	TK		
	NPN	Open	no	KY		
		Closed	yes	KK		
PNP	Closed	no	PY			
	Closed	yes	PK			
NPN	Closed	no	HY			
	Closed	yes	HK			

📄 Not all codes listed are compatible with all options. Contact Tolomatic with any questions.

YOUR MOTOR HERE

YM _____ Motor mount for non-Tolomatic motor. www.tolomatic.com

Brakes mounted on reverse parallel motor mounts (especially in vertically positioned actuators) will not prevent back driving of the screw and the load falling under gravity in the event of a timing belt failure. An inline motor mount with a fail-safe brake mounted directly to the actuator shaft or a special geared or thru-shaft reverse parallel construction should be considered if a brake is required in a safety critical application. Contact Tolomatic for alternate reverse parallel brake mounting options.

Gearheads may be used with RSA ST or GSA ST reverse parallel motor mounts. However, the torque on the belt and internal ST RP components must remain below the capabilities of the assembly to prevent belt slipping or premature failure. Contact Tolomatic for additional information if required.

RSA-ST

RSA-HT

The Tolomatic Difference Expect More From the Industry Leader:



INNOVATIVE PRODUCTS

Solutions with Endurance TechnologySM for challenging applications.



FAST DELIVERY

Built-to-order with configurable stroke lengths and flexible mounting options.

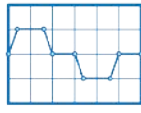

ACTUATOR SIZING

Size and select electric actuators with our online software.



YOUR MOTOR HERE[®]

Match your motor to compatible mounting plates with Tolomatic actuators.



CAD LIBRARY

Download 2D or 3D CAD files for Tolomatic products.



TECHNICAL SUPPORT

Get a question answered or request a virtual design consultation with one of our engineers.

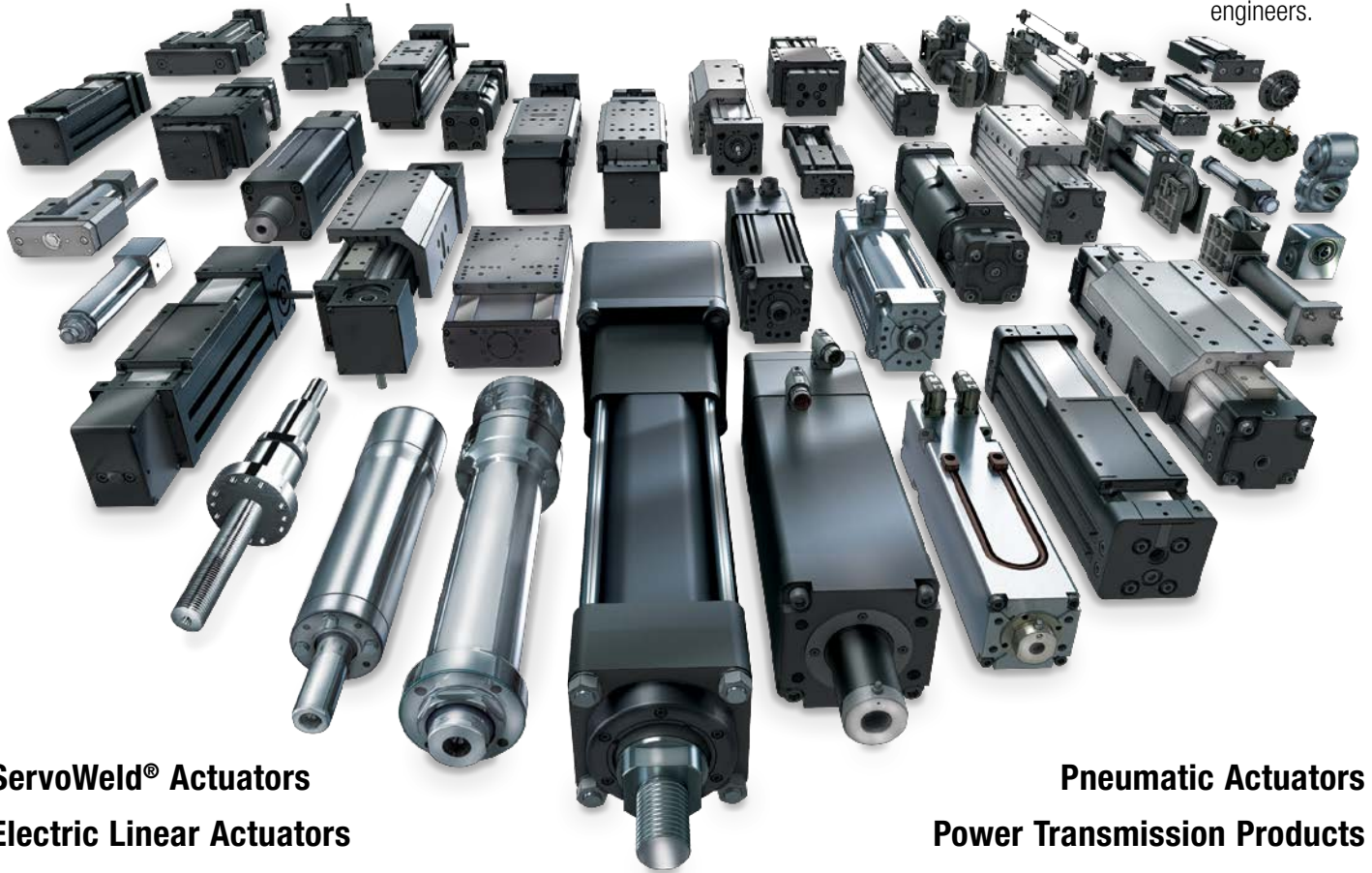

ServoWeld[®] Actuators
Electric Linear Actuators

Pneumatic Actuators
Power Transmission Products



MADE IN U.S.A.

TolomaticTM

EXCELLENCE IN MOTION

COMPANY WITH
QUALITY SYSTEM
CERTIFIED BY DNV
= ISO 9001 =
Certified site: Hamel, MN

USA - Headquarters

Tolomatic Inc.
3800 County Road 116
Hamel, MN 55340, USA
Phone: (763) 478-8000
Toll-Free: **1-800-328-2174**
sales@tolomatic.com
www.tolomatic.com

MEXICO

Centro de Servicio
Parque Tecnológico Innovación
Int. 23, Lateral Estatal 431,
Santiago de Querétaro,
El Marqués, México, C.P. 76246
Phone: +1 (763) 478-8000
help@tolomatic.com

EUROPE

Tolomatic Europe GmbH
Elisabethenstr. 20
65428 Rüsselsheim
Germany
Phone: +49 6142 17604-0
help@tolomatic.eu
www.tolomatic.com/de-de

CHINA

Tolomatic Automation Products (Suzhou) Co. Ltd.
No. 60 Chuangye Street, Building 2
Huqiu District, SND Suzhou
Jiangsu 215011 - P.R. China
Phone: +86 (512) 6750-8506
Tolomatic_China@tolomatic.com

All brand and product names are trademarks or registered trademarks of their respective owners. Information in this document is believed accurate at time of printing. However, Tolomatic assumes no responsibility for its use or for any errors

that may appear in this document. Tolomatic reserves the right to change the design or operation of the equipment described herein and any associated motion products without notice. Information in this document is subject to change without notice.

Visit www.tolomatic.com for the most up-to-date technical information