

MANUAL

For Installation, Maintenance
and Operation

IMA Series Actuators



Original instructions in English. Translations in community languages supplied as required.

Information furnished is believed to be accurate and reliable. However, Tolomatic assumes no responsibility for its use or for any errors that may appear in this document.

Tolomatic reserves the right to change the design or operation of the equipment described herein and any associated motion products without notice. Information in this document is subject to change without notice.

CONTENTS

CONTENTS	3
LIST OF FIGURES & TABLES	5
1: SAFETY	7
• 1.0 SAFETY	7
• 1.1 SAFETY SYMBOLS	7
• 1.2 SAFETY CONSIDERATIONS	8
2: IMA PRODUCT OVERVIEW	10
• 2.0 GENERAL DESCRIPTION.....	10
• 2.1 PRODUCT FEATURES.....	10
• 2.2 INSTALLATION	10
• 2.3 CABLE ROUTING.....	11
• 2.4 ACTUATOR ORIENTATION.....	11
• 2.5 EMC WIRING GUIDELINES	12
• 2.6 MOTION CONTROL SYSTEM SELECTION RECOMMENDATIONS.....	12
• 2.7 IDENTIFICATION LABEL	12
• 2.5 CERTIFICATION	12
• 2.6 MANUFACTURER	12
3: IMA ACTUATOR PRODUCT CONFIGURATION	13
• 3.1 TOLOMATIC IMA ACTUATOR SERIES CONFIGURATION	13
• 3.2 STANDARD CONFIGURATIONS AND OPTIONS.....	13
• 3.2.1 SCREW SELECTION	15
• 3.2.2 MOTOR VOLTAGE.....	15
• 3.2.3 INTERNAL HOLDING BRAKE OPTION.....	15
• 3.2.4 STANDARD MOUNTING OPTIONS	15
• 3.2.5 MOUNTING OPTIONS	15
• 3.2.6 STANDARD ROD END.....	15
• 3.2.7 ROD END OPTIONS	16
• 3.2.8 OTHER OPTIONS	16
• 3.2.9 SPECIAL OPTIONS	16
• 3.2.10 FEEDBACK DEVICE	16
• 3.2.11 CABLE & CONNECTOR(S).....	16
• 3.2.12 SERVO DRIVE	17
• 3.2.13 ROCKWELL AUTOMATION PARTNERNETWORK™ PROGRAM.....	17
4: IMA MECHANICAL INSTALLATION	18
• 4.1 TOLOMATIC IMA ACTUATOR SYSTEM CONFIGURATION	18
• 4.2 GENERAL OPERATION	18
• 4.3 COLD TEMPERATURE STARTUP PROCEDURE	19
• 4.4 PLANNING YOUR INSTALLATION	19
• 4.4.1 ALIGNMENT.....	20
• 4.4.2 SIDE LOAD CONSIDERATIONS.....	20
• 4.5 MECHANICAL INSTALLATION INSTRUCTIONS.....	20
• 4.6 MOUNTING.....	22
• 4.5 FIELD INSTALLATION OF ARO (ANTI ROTATION) OPTION.....	23
5: ELECTRICAL INSTALLATION	25
• 5.1 CONNECTOR ORIENTATION.....	25

• 5.2 FEEDBACK INFORMATION	25
• 5.3 FEEDBACK COMMUTATION	26
• 5.4 FEEDBACK COMMUTATION DETAILS.....	26
• 5.5 FEEDBACK SPECIFICATIONS.....	29
• 5.6 THERMAL SENSOR SPECIFICATIONS	30
• 5.7 CONNECTOR PINOUTS	31
• 5.7.1 TOLOMATIC STANDARD - DT1	31
• 5.7.2 ALLEN BRADLEY MP MOTOR SERIES - DA1	36
• 5.7.3 ALLEN BRADLEY VP MOTOR SERIES - DA2.....	37
• 5.7.4 BOSCH REXROTH MSK MOTOR SERIES - DB1	38
• 5.7.5 CONTROL TECHNIQUES FM MOTOR SERIES - DE1	39
• 5.7.6 CONTROL TECHNIQUES NT MOTOR SERIES - DE2.....	41
• 5.7.7 LENZE MCS MOTOR SERIES - DL1	42
• 5.7.8 SIEMENS 1F MOTOR SERIES - DS1	44
6: IMA OPERATION AND START UP CONSIDERATIONS	45
• 6.1 ATTACHING CABLES & HOMING / MECHANICAL TRAVEL LIMITS	45
• 6.2 BRAKE.....	45
7: IMA REPAIR AND MAINTENANCE.....	47
• 7.1 LUBRICATION	47
• 7.2 PERIODIC MAINTENANCE	47
• 7.3 PROCEDURE FOR LUBRICATION	50
• 7.4 TOLOMATIC IMA MAINTENANCE AND REPAIR	50
• 7.5 STORAGE RECOMMENDATIONS	52
APPENDIX A: SPECIFICATIONS	53
• A.1 ACTUATOR SPECIFICATIONS	53
• A.2 MOTOR SPECIFICATIONS:	53
• A.3 BRAKE SPECIFICATIONS	53
• A.4 SPEED VS THRUST GRAPHS	53
• A.5 CALCULATING RMS THRUST AND VELOCITY FOR CONTINUOUS DUTY:	53
• A.6 CRITICAL SPEED	54
• A.7 BALL & ROLLER SCREW LIFE.....	54
• A.8 STANDARD THERMAL SWITCH SPECIFICATIONS.....	54
APPENDIX B: TROUBLESHOOTING PROCEDURE.....	55
APPENDIX C: WARRANTY	56
• C.1 WARRANTY	56
APPENDIX D: DECLARATION OF CONFORMITY	58

LIST OF FIGURES & TABLES

Figure 1.1: Do not carry IMA by connectors or cables.	9
Figure 2.1: Tolomatic IMA Actuator	10
Figure 2.2: IMA major components	10
Figure 2.3: Recommended routing of Tolomatic IMA Actuator cabling.	11
Figure 2.4: 1. & 2. Recommended IMA thrust rod orientation is down or horizontal. 3. Due to increased risk of contamination and ingress never orient the IMA actuator with the thrust rod up.	11
Figure 2.2: Tolomatic IMA Actuator identification label.	12
Figure 3.1: Tolomatic IMA Actuator ordering codes and descriptions	14
Figure 3.2: Standard mounting for the IMA is four (4) threaded holes on the front face (rod end) of the actuator	15
Figure 3.3: Optional mounting for the Tolomatic IMA Actuator.....	15
Figure 3.4: Standard rod end for the IMA is internal threads.....	15
Figure 3.5: Rod End Options for the Tolomatic IMA Actuator	16
Figure 3.5: Rod End Options for the Tolomatic IMA Actuator	16
Figure 4.1: Typical connections for a single-axis system with an Tolomatic IMA Actuator with optional brake to a RSW servo system drive	18
Figure 4.2: Side load must not exceed maximum values represented by the lines in the graph.....	20
Figure 4.3: Do not carry IMA by connectors or cables.	21
Figure 4.4: Use straps and winch to position heavy IMA actuator.....	21
Figure 4.5: Hold thrust rod stationary using a wrench on the flats of the rod end when attaching accessories, linkages or load to the actuator. Two wrenches are used here: The crescent wrench prevents the thrust rod from rotating, the torque wrench will fasten the spherical rod eye option to the actuator rod end. Torque values provided in Table 4.1	22
Table 4.1: Rod end torque recommendations	22
Table 4.2: Tapped hole torque recommendations.....	23
Table 4.3: Mounting Plate (MP2) Clearance Hole Bolt and Torque Requirements (Minimum Fastener Grade 8.8).....	23
Table 4.4: Front Flange Mount (FFG) Clearance Hole Bolt and Torque Requirements (Minimum Fastener Grade 8.8).....	23
Figure 4.6: View of ARO (Anti Rotate Option)	23
Figure 5.3: Connector rotation. Note that the Tolomatic standard connectors may be rotated from -90° to +180° allowing for cables to connect toward the front (rod end, as manufactured), to either side, both sides, or back of actuator.	25
Figure 5.4: Drawing of box mount connectors used on some Tolomatic IMA Actuators.	25

Figure 5.5: Thrust rod movement relative to motor rotation	26
Figure 5.6: Back EMF Voltage vs Electrical Angle	27
Figure 5.7: Back EMF Voltage Phase to Phase vs Electrical Angle	27
Figure 5.8: Hall Alignment	28
Figure 5.9: Motor rotational position at 0	28
Figure 5.10: Motor rotational position at 90	29
Figure 6.1: Fastest Engage / Disengage time, least protection.....	45
Figure 6.2: Increased Engage / Disengage time, best protection.....	46
Figure 7.1: Roller Screw Lubrication Interval Graph.....	48
Figure 7.1: A standard grease zerk allows periodic relubrication for Tolomatic IMA Actuators. This can be done without removing the actuator from its installation.	50

1: SAFETY

1.0 Safety

1.1 Safety Symbols

General

Read completely through the applicable sections of the manual before the equipment/unit is unpacked, installed or operated. Pay careful attention to all of the dangers, warnings, cautions and notes stated in the manual. Serious injury to persons or damage to the equipment may result if the information in the manual is not followed.

Safety Symbols

Items that are specifically marked DANGER, WARNING, CAUTION, PROHIBITIVE, MANDATORY ACTION, or NOTE! are arranged in a hierarchical system and have the following meaning:



Indicates a very hazardous situation which, if not avoided, could result in death or serious injury. This signal word is limited to the most extreme situations.



Indicates a potentially hazardous situation which, if not avoided, could result in death or serious injury.



Indicates a potentially hazardous situation which, if not avoided, may result in property damage, minor or moderate injury.



Indicates Prohibited Action



Indicates Mandatory Action



Information that requires special attention is stated here.



WARNING FOR HOT SURFACES

WARNING! Normal operating temperature of weld actuator can range from 135 degrees F (57°C) to 175 degrees F (79°C).

1.2 Safety Considerations

Proper and Safe Use of Product

Fail Safe e-Stop Recommendations

A means for a fail safe e-stop is highly recommended to ensure equipment and personal safety. The e-stop should provide a means to remove main power from the actuator to cease and prevent any unwanted motion.

Device Damage Prevention

To prevent permanent damage to the device, proper care should be taken not to exceed published voltage, current, temperature, and load/force ratings. In addition, proper mechanical assembly and proper wiring should be verified and safety measures checked before applying power to the complete equipment package.

The only field maintenance that may be performed on the IMA include lubrication and replacement of the rod wiper. All other repair or maintenance for the IMA must be performed at Tolomatic.

Personal Safety

During normal operation the actuator can become hot, especially the motor housing. It is highly recommended to display proper safety notices and implement proper safety measures to prevent contact with hot surfaces. In addition, the case ground should be tied to an earth ground to prevent the presence of case voltage.

During normal operation, the actuator rod travels in and out creating a possible pinch point.

Proper guarding and signage must be used prevent entry into possible pinch zones and contact with hot surfaces. It is highly recommended to display proper safety notices and implement proper safety measures to prevent contact with hot surfaces.

Handling and Unpacking

When unpacking and handling the actuator, care should be taken not to drop the actuator as this can damage the connectors, internal electronics, or cause misalignment of the actuator feedback device. Damage the internal mechanical components may cause poor performance or render the actuator non-functional. Since this is an electromechanical device, proper ESD measures should be taken to avoid static electricity from contacting the signal and power lines of the device. As this can damage the internal mechanical components rendering the actuator damaged or non-functional.

Packing and Transport



NOTE!

Package actuator to prevent damage during transport. It is recommended that the actuator be returned in its original packaging. If the original packaging is not available, then follow these recommendations.

1. Foam in place if possible.
2. Reinforce ends of box with multiple layers of cardboard or wood to prevent the actuator from breaking through the packaging during shipment.
3. Support the connectors or cables so that enough packaging or foam is in place to prevent shipping damage.
4. It is best to ship one unit per container because individual items that are not isolated with stable packaging (foam in place) from each other often get damaged during shipment.
5. When shipping more than one unit in a single container, it is recommended to foam in place to prevent damage during shipping to both the units and the packaging.
6. Add the RMA on the outside of the packaging. Failure to do so will delay processing.

⚠ CAUTION CAUTION!



Figure 1.1: Do not carry IMA by connectors or cables.

The Tolomatic IMA Actuator weight range is approximately 3.0 to 42 kg (6.6 to 93 lb). Special care must be taken when lifting this device. Do not carry by the connectors or cables. The connectors are not rated to support the weight of the actuator.

Modifications to the Equipment

⚠ WARNING WARNING!

The manufacturer takes no responsibility whatsoever if the equipment is modified or if the equipment is used in any way beyond performance specifications. Unauthorized modifications or changes to the equipment are strictly forbidden, and void all warranties.

Repair and Maintenance

⚠ WARNING WARNING!

All power and supply media must be shut OFF before any work is performed on any equipment that is associated with the Tolomatic IMA Actuator. The only field maintenance that may be performed on the Tolomatic IMA Actuator is lubrication. All other repair or maintenance for the Tolomatic IMA Actuator must be performed at Tolomatic.

Requirement Regarding Personnel

📄 NOTE!

All personnel must be completely informed regarding all safety regulations and the function of the equipment.

Risk Area and Personnel

When installed, pinch points are generated capable of high damaging forces. The risk area surrounding the Tolomatic IMA Actuator must either be enclosed or clearly marked, including display signage in accordance with all applicable national and international legal requirements. The risk area must be protected by a safety system that stops the equipment if anyone enters the risk area. Personnel who enter the risk area must be authorized, trained and qualified for the different tasks inside the risk area.

2: IMA PRODUCT OVERVIEW

2.0 General Description

Tolomatic IMA Actuators



Figure 2.1: Tolomatic IMA Actuator

The IMA is a compact, durable, high force rod-style actuator. The IMA integrates a servo motor into the mechanical design to minimize the overall envelope. The patented design allows for easy re-lubrication without disassembly for extremely long service life.

2.1 Product Features

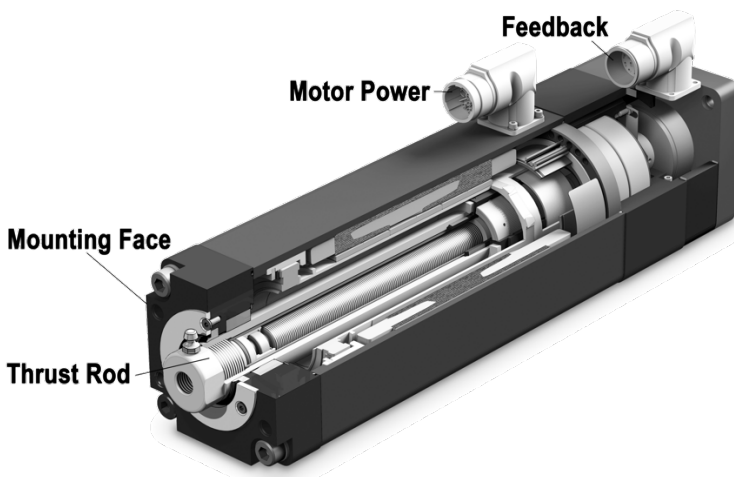

Figure 2.2: IMA major components

2.2 Installation

The IMA is a compact high force screw drive servo actuator. The IMA provides linear motion of the moveable rod

developing the required thrust force and velocity in a variety of applications.

⚠ WARNING **WARNING!**

Before installation and commissioning of the equipment, this manual and all accompanying manufacturer documents and manuals **MUST** be completely read by the appropriate personnel. All warning texts must be given special attention.

2.3 Cable Routing

It is recommended that the power and signal cables for Tolomatic IMA Actuators be routed as far apart as possible to minimize electrical noise in communication cables.

Over time, liquid contaminants such as oil and cleaning solutions may accumulate on the cables and into the connectors if they are an exposed type. To minimize the introduction of contaminants to the connector, route the cables so that there is a loop in the cable just prior to its attachment to the connector.

Examples are shown depending on the orientation of the connectors. Units mounted in such a way that the connectors are on the bottom surface of the actuator require no looping.

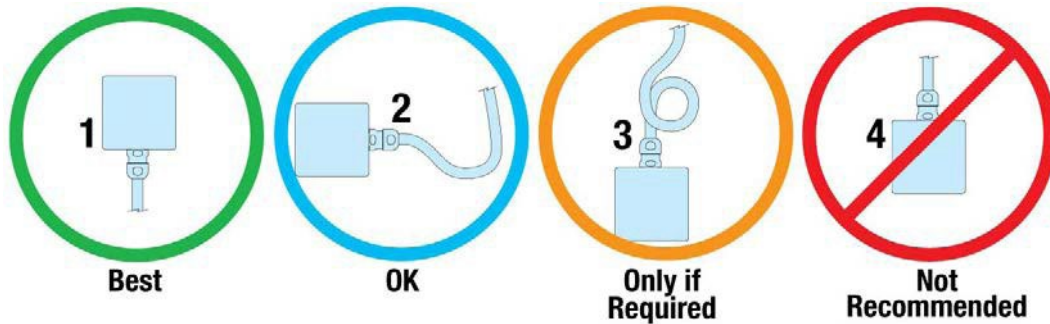

Figure 2.3: Recommended routing of Tolomatic IMA Actuator cabling.



NOTE!

The standard cables from Tolomatic are not flex rated and have a minimum bend radius of 3.75 in (95mm). Any repeated flexing or excessive bending can result in broken conductors and intermittent faults.

2.4 Actuator Orientation

1. Rod End Down (Best) 2. Rod End Horizontal (Good) 3. Rod End Up (Never)

It is not recommended to mount the IMA with the thrust rod pointing upwards. Mounting the thrust rod vertically increases risk of contamination and ingress..

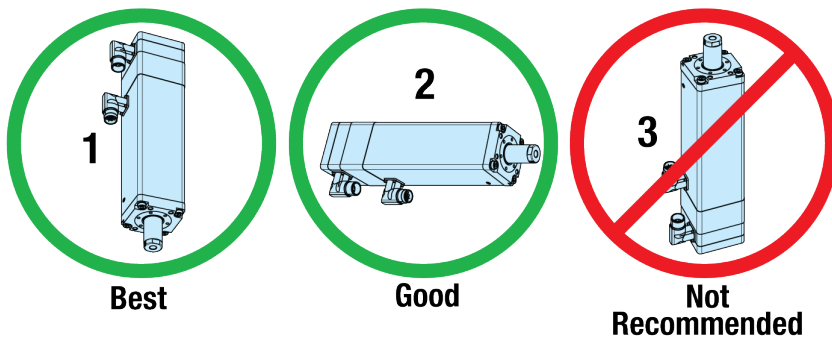

Figure 2.4: 1. & 2. Recommended IMA thrust rod orientation is down or horizontal. 3. Due to increased risk of contamination and ingress never orient the IMA actuator with the thrust rod up.

2.5 EMC Wiring Guidelines

Shielding and grounding

Tolomatic supplied cables have the proper shielding and are recommended for proper installation. If additional or alternate cables are required, braided shield cables are recommended. The standard cables provided by Tolomatic have an overall braided shield. To minimize EMI and ensure system reliability, all shield drain wires from all cables should be tied to a common earth ground. Also, make sure to follow the drive manufacturer's recommendations on proper cable dressing, shield and ground connections to ensure reliable operations. To minimize EMI and ensure system reliability, shield drain wires from all cables should be tied to a common earth ground.

WARNING!

Thrust rod is not electrically connected to ground. The thrust rod should be earth grounded during installation for safety when possible.

2.6 Motion Control System Selection Recommendations

It is recommended that all servo drives be selected based on the following important parameters:

- a) CE and UL approved system
- b) Thermal switch input
- c) Servo drive sizing key parameters for IMA-S
 - i) Peak current
 - ii) Voltage
 - iii) Peak RPM
 - iv) Max current switching frequency

2.7 Identification Label

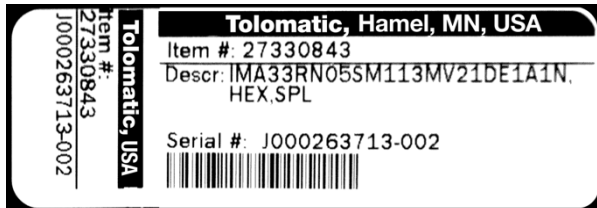

Figure 2.2: Tolomatic IMA Actuator identification label.

Do not remove the identification label. Do not render it unreadable.

2.5 Certification



2.6 Manufacturer

Tolomatic, Inc.
3800 County Road 116, Hamel, MN 55340, USA
Phone: 763-478-8000
Sales@Tolomatic.com

3: IMA ACTUATOR PRODUCT CONFIGURATION

3.1 Tolomatic IMA Actuator Series Configuration

Tolomatic IMA Actuator Product Overview

- Four sizes: IMA22, IMA33, IMA44, IMA55
- Ball Screw Options: 5, 10, 20 and 25 mm lead
- Roller Screw Options: 4, 5 and 10 mm lead
- Motor windings: 230 Vac & 460 Vac
- IP65 standard; IP67 optional
- External Anti-Rotate
- Feedback choices (but not limited to):
 - Digital Incremental
 - Multi-turn Absolute Encoder
 - Resolver
- Connector choices (but not limited to):
 - DT1: Tolomatic Standard
 - DE1: Nidec/Control Tech., FM
 - DE2: Nidec/Control Tech., NT
 - DA1: Allen Bradley MP
 - DA2: Allen Bradley VP
 - DB1: Bosch Rexroth MSK
 - DL1: Lenze MCS
 - DS1: Siemens 1F



NOTE!

For performance data and specifications please refer to the Tolomatic [IMA Actuator brochure #2700-4000](#)

3.2 Standard Configurations and options



NOTE!

NOTE Please see Tolomatic [IMA Actuator brochure #2700-4000](#) for complete information on ordering codes. Use 3D CAD files (available at www.tolomatic.com) for critical dimensions.

IMA - Integrated Motor Actuator

Ordering

MODEL SELECTION (MUST BE IN THIS ORDER)

IMA 44 BN05 SM304-8 MV23 DT1D1 N ALC MP2 IP67 CR5

OPTIONS (IN ANY ORDER)

MODEL	
IMA	Integrated Motor Actuator
IMAWP*	Integrated Motor Actuator
*IMAWP: lead time will vary from standard 15 day delivery, contact Tolomatic	

SIZE	
22	22 Series Actuator
33	33 Series Actuator
44	44 Series Actuator
55	55 Series Actuator

NUT / SCREW				
Screw/Nut combinations available				
22	33	44	55	Description
BN05	BN05	BN05	BN05	Ball Nut, 5 mm lead
BN10	BN10	BN10	BN10	Ball Nut, 10 mm lead
—	BN20	—	BN20	Ball Nut, 20 mm lead
—	—	BN25	—	Ball Nut, 25 mm lead
—	RN04	RN04	—	Roller Nut, 4 mm lead
—	RN05	RN05	RN05	Roller Nut, 5 mm lead
—	RN10	RN10	RN10	Roller Nut, 10 mm lead

STROKE LENGTH	
SM_ _ _ _	Stroke, (76.2 to 457.2) enter stroke length in millimeters
NOTE: Maximum stroke for IMA22 is 12" (304.8 mm)	

MOTOR VOLTAGE	
MV21*	230 Vac, Motor Voltage, 1 Stack Winding
MV41*	460 Vac, Motor Voltage, 1 Stack Winding
MV23	230 Vac, Motor Voltage, 3 Stack Winding
MV43	460 Vac, Motor Voltage, 3 Stack Winding
NOTE: 22/33 size actuators only	

BRAKE OPTION	
N	NO Brake
B	Brake

ROD END OPTIONS	
—	Standard, female, internally threaded rod end
MET	Male Externally Threaded Rod End
SRE	Spherical Eye Rod End
RCL	Clevis Rod End
ALC	Alignment Coupler*
NOTE: For IMA44 & IMA55 Only ALC (Alignment Coupler) requires ARO (Anti-Rotate) for proper operation	

MOUNTING OPTIONS	
—	Standard Face Mount
MP2	Mounting Plates - 2 req.
FFG	Front Flange Mount
TRF	Trunnion Mount, Front
TRR	Trunnion Mount, Rear
PCD	Clevis Mount, Rear
MST	Side Mount (tapped holes on 3 sides)

OTHER OPTIONS	
IP67**	Ingress Protection Rating
ARO	Anti Rotate
LUB	Food Grade Grease
**IP67 is not available with DE2 (Control Techniques NT connectors) Not available on any IMA22	

CABLES	
CR5	Tolomatic standard 6m flying lead cables, power and feedback
CR10	Tolomatic standard 10m flying lead cables, power and feedback
For custom cable lengths please contact Tolomatic. Lead times will vary.	
NOTE: only use these cable options with DT1 motor connector, use cables from drive manufacturer for all others.	
For IP rated cables contact Tolomatic	

MOTOR SERIES CONNECTORS	FEEDBACK DEVICE
Allen Bradley MP DA1	A1 SICK Hipurface
Allen Bradley VP DA2	A2 SICK Hipurface DSL
Bosch Rexroth MSK DB1	A1 SICK Hipurface
Nidec/Cntl. Tech., FM DE1	A1 SICK Hipurface
Nidec/Cntl. Tech., FM DE1	R1 Resolver
Nidec/Cntl. Tech., FM DE1	D1 Incremental
Nidec/Cntl. Tech., NT DE2	D1 Incremental
Lenze MCS DL1	A1 SICK Hipurface
Lenze MCS DL1	R1 Resolver
Lenze MCS DL1	D1 Incremental

MOTOR SERIES CONNECTORS	FEEDBACK DEVICE
Siemens 1F DS1	H1 Heidenhain Endat 2.2
Tolomatic Standard DT1	D1 Incremental
Tolomatic Standard DT1	R1 Resolver
Tolomatic Standard DT1	A1 SICK Hipurface
Tolomatic Standard DT1	H1 Heidenhain Endat 2.2
Motor Connector or Feedback Device Not Shown	DX ***See below

*** Tolomatic can configure the IMA to connect to a drive using cables from other leading drive manufacturers including but not limited to those listed below.

ABB	Fanuc	Motoman	SEW
Aerotech	Kawasaki	Nachi	Stober
B&R	Kollmorgen	Omron	Others
Baldor	Kuka	Parker	
Beckhoff	Lenze	Schneider Electric	

This integration includes customer specified motor thermal protection, feedback, connectors, flying lead/connectorized extension cables and motor alignment.

For more information about combinations not listed above, or other customizations, contact Tolomatic.

Figure 3.1: Tolomatic IMA Actuator ordering codes and descriptions

3.2.1 Screw Selection

Tolomatic IMA Actuator: RN04, RN05, RN10: Roller nuts with 4mm, 5mm or 10 mm lead.
BN05, BN10, BN20, BN25: Ball nuts with 5mm, 10mm, 20mm or 25mm lead
Contact Tolomatic for application review and assistance in selecting a screw technology.

3.2.2 Motor Voltage

Available with 230 Vac or 460 Vac. With 1, and 3 stack windings.
Contact Tolomatic for application review and assistance in selecting voltage and windings.

3.2.3 Internal Holding Brake Option

N=No Brake, B=24V Brake, 3= A spring held electronically released holding brake (parking brake) is available. The holding force of the brake is capable of holding the continuous force of the actuator. The brake is spring set and releases when voltage is applied to the brake. A separate power source is required.

3.2.4 Standard Mounting Options



Figure 3.2: Standard mounting for the IMA is four (4) threaded holes on the front face (rod end) of the actuator.

Standard mounting for the IMA is four (4) threaded holes on the front face (rod end) of the actuator. There are also Side Mounting Holes, 2 sides & bottom (no photo)

3.2.5 Mounting Options

Other mounting options include: Side mounting holes (a total of 12 mounting holes on both sides and bottom of actuator), mounting plates, rear clevis, front flange, front trunnion and rear trunnion.

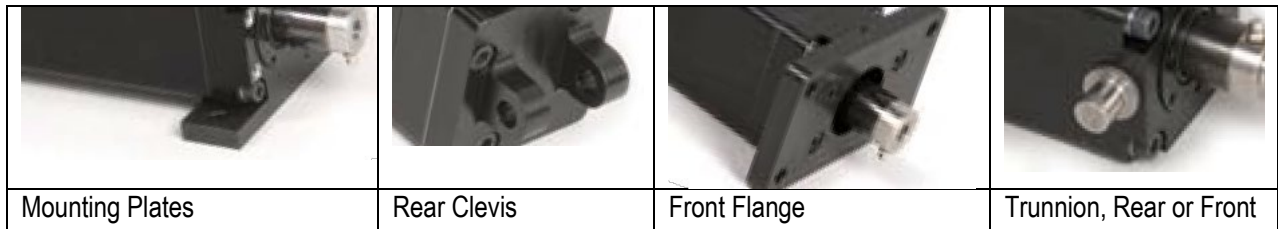

Figure 3.3: Optional mounting for the Tolomatic IMA Actuator

3.2.6 Standard Rod End



Figure 3.4: Standard rod end for the IMA is internal threads.

3.2.7 Rod End Options

Other rod end options include: External threads, clevis, spherical eye and alignment coupler.



Figure 3.5: Rod End Options for the Tolomatic IMA Actuator



NOTE!

NOTE: ALC (Alignment Coupler) requires ARO (Anti-Rotate) for proper operation.

3.2.8 Other Options

Other IMA options available are: IP67 rating for protection against water and dust ingress; anti rotate option
The IMA is available with a standard ingress rating of IP65. The IP67 option can be added to help further protect against water and dust ingress.

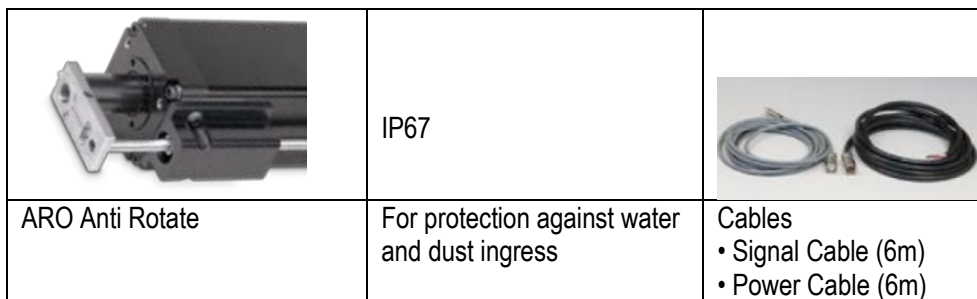

Figure 3.5: Rod End Options for the Tolomatic IMA Actuator

3.2.9 Special Options

Include: Longer stroke length other than standard; White Paint; Food Grade Grease; Hex Rod; Special Options

3.2.10 Feedback Device

Contact Tolomatic for application review and assistance in selecting feedback device. The IMA is offered with the following feedback device technologies as standard: Incremental, Resolver, and SICK Hiperface, SICK Hiperface DSL, and Heidenhain EnDat 2.2 multi-turn absolute feedback devices.

3.2.11 Cable & Connector(s)

Connectors are matched to selected feedback device. Contact Tolomatic for application review and assistance in selecting feedback device.

Cable Leads Information

CR5 and CR10: Cables are matched for each feedback / motor combination in 5 and 10 meter lengths.



WARNING!

In applications with lengths exceeding 10 meters for both feedback and power cables, there will be potential for

issues related to excessive feedback noise and partial discharge inception voltage (PDIV) that can break down the servo motor's insulation system eventually causing shorts.

3.2.12 Servo Drive

The Tolomatic IMA Actuators functions in the same way as a brushless servo motor. A servo drive is used to power and control the actuator. Please consult the servo drive manufacturer when sizing and selecting a servo drive for use with Tolomatic IMA Actuator.



NOTE!

The Tolomatic IMA Actuator must be ordered with all desired options. Field installation of options generally cannot be done. Call Tolomatic for complete details.

3.2.13 Rockwell Automation PartnerNetwork™ Program



Bronze Technology Partner

Tolomatic has aligned with Rockwell to provide customers with the best automation solutions for their motion control applications. Through the Encompass third-party product referencing program, you can quickly locate products that best solve your application challenges. Available Tolomatic products include the RSA, GSA, ERD, and IMA electric rod actuators and the MXE rodless screw drive and MXB rodless belt drive actuators. All these products are compatible with Rockwell Automation's servo products and extended motion control solutions. Visit [Rockwell's PartnerNetwork™ Encompass program site](#) for more information.

Enabled™ Technology Licensing Partner

The Rockwell Automation Enabled Technology partnership ensures that Tolomatic's IMA integrated servo motor actuators perform with the same compatibility as Rockwell servo motors. The results are the ability to integrate the Rockwell architecture to a larger variety of products to better service our customer base.

Tolomatic Resources

For additional information regarding the integration of the IMA to an Allen Bradley/Rockwell drive see:

TECH NOTE: Interfacing the Tolomatic IMA Actuator and Absolute Encoder with Allen Bradley Servo Drives: <https://www.tolomatic.com/info-center/resource-details/324>

SOFTWARE: IMA-Rockwell CMF (blb file) Import Tool: <https://www.tolomatic.com/information-center/resource-details/687>

TECH NOTE: IMA-Rockwell Logix CMF (blb file) File Import Instructions: <https://www.tolomatic.com/info-center/resource-details/688>

4: IMA MECHANICAL INSTALLATION

⚠ WARNING WARNING!

Before installation and commissioning of the equipment, this manual and all accompanying manufacturer documents and manuals MUST be completely read by the appropriate personnel. All warning texts must be given special attention.

4.1 Tolomatic IMA Actuator System Configuration

Tolomatic IMA Actuator series actuators incorporate an integral brushless servo motor. The design of the motor with the proper feedback device allows the IMA to be powered by nearly every brand of brushless drive on the market. This flexibility allows the IMA actuator to be used in the highest performing single and multi-axis motion control systems. It is recommended that all servo amplifiers and drives be selected based on the following important parameters:

- a) CE and UL approved system
- b) Thermal switch input
- c) Drive sizing key parameters for Tolomatic IMA Actuator
 - i) Peak current
 - ii) Voltage
 - iii) Peak RPM
 - iv) Max current frequency

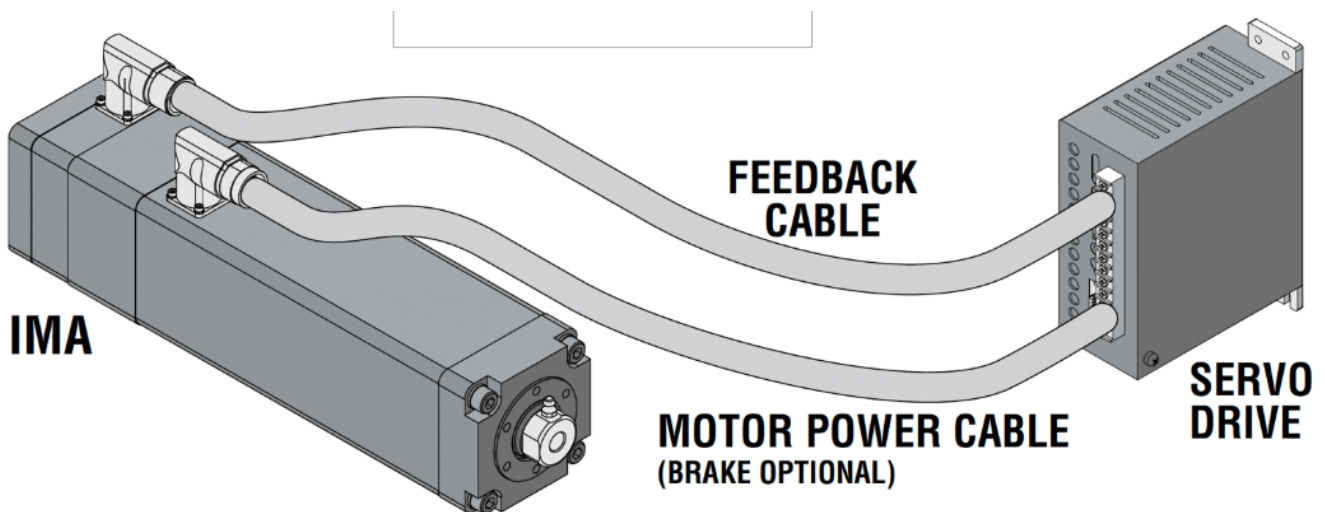

Figure 4.1: Typical connections for a single-axis system with an Tolomatic IMA Actuator with optional brake to a RSW servo system drive

4.2 General Operation

General Operation

The IMA actuator functions by translating the rotary motion of the integral brushless servo motor into linear motion using a screw mechanism. The linear travel, speeds and forces are controlled in conjunction with a brushless servo drive.

When ordered the IMA actuator can be configured with any one of the following feedback devices: Digital encoder, resolver, multi-turn absolute encoder. Please confirm you are using a version of software that supports the correct feedback device and operation of IMA actuators.

The relationship between the rotary motion of the motor and the linear motion of the actuator corresponds to the following relationships:

Linear distance traveled = (motor revolutions) * (screw lead)

Linear Speed = ([motor RPM]/60) * (screw lead)

Linear Thrust (kN) = Motor torque (Nm) * 2 * π * pitch (rev/mm) * screw efficiency

or

Linear Thrust (lbf) = Motor torque (in•lb) * 2 * π * pitch (rev/in) * screw efficiency

⚠ CAUTION CAUTION!

Motor RMS current must be maintained at a level below the continuous current rating of the Tolomatic IMA Actuator or damage to the motor stator will result.

The peak current setting must be maintained at a level below the peak current rating of the Tolomatic IMA Actuator or damage to the motor stator will result.

⚠ CAUTION CAUTION!

Care should be taken to not exceed the physical travel limits of the Tolomatic IMA Actuator. Doing so will cause the actuator to reach mechanical end of stroke internally. Although protected by the end of stroke bumpers, repeatedly reaching internal end of stroke can physically damage the screw and the internal components of the actuator.

⚠ CAUTION CAUTION!

Power and Feedback cable lengths shall not exceed 10 meters. If the application requires cable lengths longer than 10 meters, please contact Tolomatic engineering for review.

4.3 Cold Temperature Startup Procedure

If startup ambient temperature is between 0-10 degrees Celsius, it is recommended to cycle the Tolomatic IMA Actuator (see recommended motion profile below) to bring the temperature up to operating temperature before proceeding with operating or calibrating the system. Initiating this startup procedure will lower the friction caused by cold temperatures and result in more accurate calibration of the system and better force repeatability performance during operation. If a motion profile other than recommended below will be used for the Cold Temperature Startup Procedure, contact Tolomatic for review of the motion profile before operating the actuator.

Recommended Motion Profile:

- Extend & retract full stroke of actuator at linear speed of 150 mm/sec for 5 or 4 mm lead screws and 300 mm/sec for 10 mm lead screws
- Dwell 1 second
- Repeat 75 times

4.4 Planning Your Installation

To operate the actuator in compliance with the relevant safety regulations maximum performance limits must be observed.

⚠ CAUTION CAUTION!

When mounting your actuator in vertical or inclined positions be sure to include safety measures that control the

working mass should the drive screw fail. Uncontrolled moving masses can cause injury or damage to property. If the screw drive fails, due to wear or excessive load, gravity may cause the working mass to drop.

CAUTION CAUTION!

For bench or fixture setup and testing of Tolomatic IMA Actuators, the actuator thrust rod must be anti-rotated by a fixture and the actuator securely retained to the bench or fixture. Never use a hand held wrench/device to provide the anti-rotate function while the motor is powered as contact with the internal end of stroke may send the wrench/device flying and may harm the operator or damage the actuator.

4.4.1 Alignment

Alignment of the actuator with respect to the application load and axis of motion is essential to minimize side loading. The IMA is not meant to be used in applications where side loading occurs as side loading will reduce the life of the actuator and rod seals.

4.4.2 Side Load Considerations

CAUTION CAUTION!



Excessive side load on the output thrust rod of the actuator will dramatically reduce the life of the actuator and should be avoided. Side load can be caused from misalignment or loading that is not inline with the actuator output thrust rod.

The graph shows the maximum side load values for the Tolomatic IMA Actuators. Measures shall be established to limit any side loading that exceeds these values.

For maximum service life, external guiding is recommended to minimize side loading to the thrust rod and provide consistent alignment throughout service life.

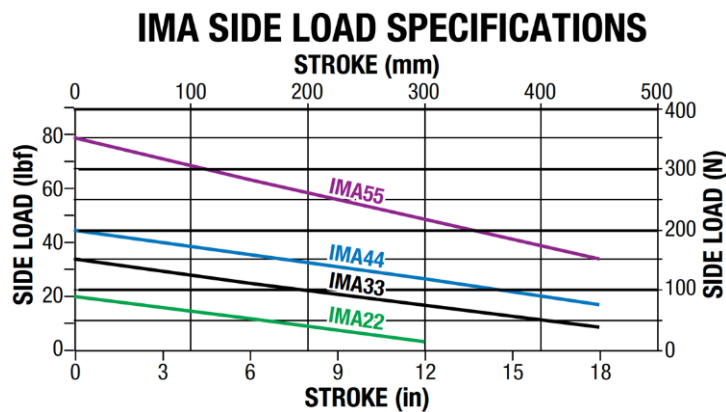

Figure 4.2: Side load must not exceed maximum values represented by the lines in the graph

4.5 Mechanical Installation Instructions

1. Remove packaging
2. Carefully remove linear actuator from package. *Consider the weight of the actuator. Depending on the configuration, the actuator can weight up to approximately 42 kg (92.6 lb)



Figure 4.3: Do not carry IMA by connectors or cables.

⚠ CAUTION CAUTION!

The Tolomatic IMA Actuator weight range is approximately 3.0 to 42 kg (6.6 to 92.6 lb). Special care must be taken when lifting this device. Do not carry by the connectors or cables. The connectors are not rated to support the weight of the actuator.

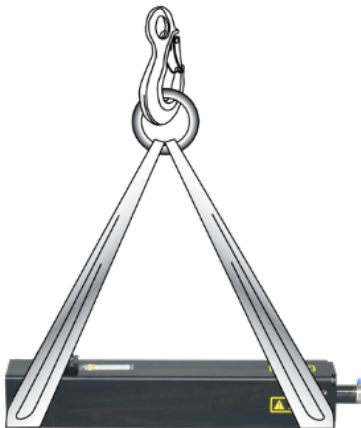

Figure 4.4: Use straps and winch to position heavy IMA actuator.

3. Visually inspect the actuator for damage
4. Notify the carrier of any shipping damage immediately
5. If the actuator is mounted in a vertical or inclined (sloping) position, include safety measures that control the work load in case of a screw failure.
6. Consider anti-rotation of the rod end. The actuator's thrust rod must be kept from rotating in order to achieve linear motion. If the application's tooling and load is free to rotate, order an IMA model with external anti-rotation (ARO) to prevent the rod from rotating.
7. It is recommended to install the actuator with rod-end down or at a downward inclination to achieve the best seal ingress protection.
8. Follow recommendations for actuator orientation and cable routing.
9. Ensure sufficient clearance around the actuator to allow for airflow and cooling.
10. Follow installation mounting considerations and specifications for each mounting configuration during installation.

4.6 Mounting

Thrust Rod Attachment

The design of the Tolomatic IMA Actuator allows the extending rod to rotate. This provides simple setup of the actuator by allowing the user to rotate the rod and thread it in and out of the actuator for mechanical attachment or system testing. This feature also requires that the rod be kept from rotating when used in its dedicated application to insure proper linear motion. In most applications, such as those where the load is coupled to an external mechanical guide, or some other support device, the load cannot rotate, and thus provides anti-rotation for the extending rod of the actuator.



Figure 4.5: Hold thrust rod stationary using a wrench on the flats of the rod end when attaching accessories, linkages or load to the actuator. Two wrenches are used here: The crescent wrench prevents the thrust rod from rotating, the torque wrench will fasten the spherical rod eye option to the actuator rod end. Torque values provided in Table 4.1

CAUTION!

Take precautions to cause no damage to the actuator's grease zerk throughout the following process.

WARNING!

APPLYING TORQUE TO THE THRUST ROD MAY DAMAGE THE ACTUATOR. Avoid this by using a wrench to prevent the thrust rod from rotating while attaching the load, linkages or accessories to the rod end. When attaching the load, linkages or accessories to the rod end, it is recommended to have the thrust rod fully retracted.

Thrust Rod Connection:

ROD END ATTACHMENT FOR ROUND ROD ACTUATOR: Hold flats on round rod stationary using a fixture, vise, or opposing wrench. Torque weld gun connection linkage or rod eye up to table value shown:

ROD END ATTACHMENT FOR ACTUATOR WITH ARO OPTION: Hold flats on the thrust rod stationary using a fixture, vise, or opposing wrench. Do not rely on the anti-rotate feature to oppose the installation torque.

Torque rod end linkage or rod eye up to table value shown:

Internal Threads

M8	11 N-m
	8 ft-lb

M12	70 N-m
	52 ft-lb

M20	180 N-m
	133 ft-lb

M27	500 N-m
	369 ft-lb

External Threads (MET)

M10	14 N-m
	10 ft-lb

M16	90 N-m
	67 ft-lb

M20	180 N-m
	133 ft-lb

M27	500 N-m
	369 ft-lb

Table 4.1: Rod end torque recommendations

Tapped Hole Mounts Recommended Torque

Front / Rear / Side Mount Holes

M6	3 N-m	M8	30 N-m	M12	85 N-m
	2 ft-lb		22 ft-lb		63 ft-lb

Table 4.2: Tapped hole torque recommendations

Mounting Plate (MP2) Clearance Hole Bolt and Torque Requirements (Minimum Fastener Grade 8.8)

M8	11 N-m	M10	30 N-m	M14	100 N-m
(IMA22)	8 ft-lb	(IMA 33/44)	22 ft-lb	(IMA55)	74 ft-lb

Table 4.3: Mounting Plate (MP2) Clearance Hole Bolt and Torque Requirements (Minimum Fastener Grade 8.8)

Front Flange Mount (FFG) Clearance Hole Bolt and Torque Requirements (Minimum Fastener Grade 8.8)

M8	11 N-m	M12	26 N-m	M14	100 N-m	M16	115 N-m
(IMA22)	8 ft-lb	(IMA33)	19 ft-lb	(IMA44)	74 ft-lb	(IMA55)	85 ft-lb

Table 4.4: Front Flange Mount (FFG) Clearance Hole Bolt and Torque Requirements (Minimum Fastener Grade 8.8)

4.5 Field Installation of ARO (Anti Rotation) Option

The design of the IMA actuator allows the extending rod to rotate. This provides simple setup of the actuator by allowing the user to rotate the rod and thread it in and out of the actuator for mechanical attachment or system testing. This feature also requires that the rod be kept from rotating when used in its dedicated application to insure proper linear motion. In most applications, such as those where the load is coupled to linear bearings, or some other support device, the load cannot rotate, and thus provides anti-rotation for the extending rod of the actuator. For applications in which the load is free to rotate, Tolomatic offers the anti-rotation systems shown below.

⚠ WARNING WARNING!

The anti-rotate option (ARO) is not a guide or support mechanism. It is intended only as an anti-rotate device.

ANTI ROTATE (ARO)

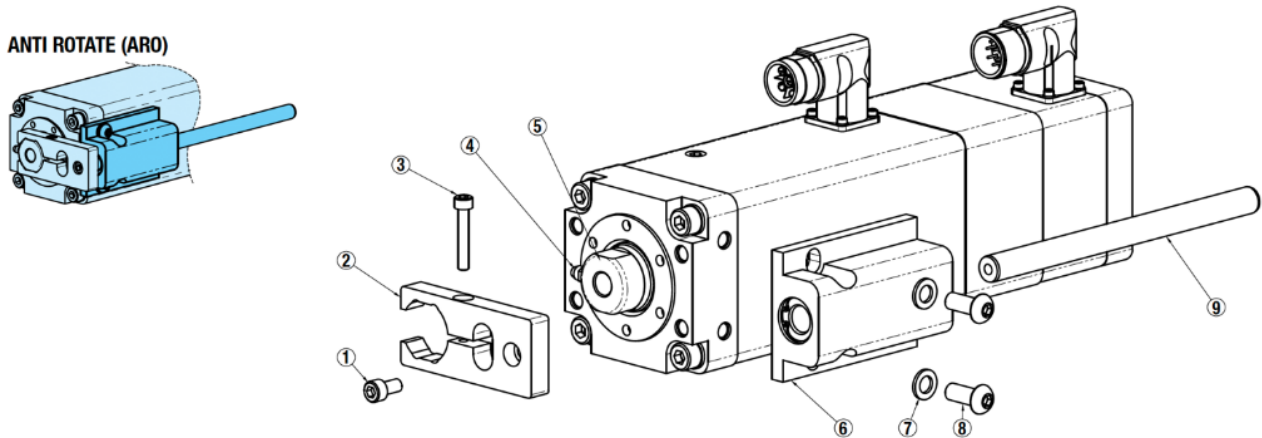

Figure 4.6: View of ARO (Anti Rotate Option)

ARO ATTACHMENT PROCEDURE / GUIDELINES

Recommended tools: 4, 5, 6 and 10 mm hex keys (allen wrenches), small dead-blow hammer.

⚠ CAUTION CAUTION!

Improper alignment of the anti-rotate shaft may result in binding and / or side loading which may reduce the life of the actuator.

⚠ CAUTION CAUTION!

Take precautions to cause no damage to the actuator's grease zerk throughout the following process.

1. Assemble Fastener [#3] into the Anti-Rotate Clamp [#2] finger-tight, then back off one (1) turn.
2. Assemble Anti-Rotate Clamp [#2] onto Rod End [#5] orientated such that the shallow counterbore faces the non-working end of the actuator and the clamp's opening straddles the Grease Zerk [#4]. Engage the flats of the Anti-Rotate Clamp [#2] with the flats of the Rod End [#5]. Light tapping with a dead-blow hammer may be necessary to seat the Anti-Rotate Clamp [#2] up against the thrust tube. When ensuring the Anti-Rotate Clamp [#2] doesn't shift, torque the Fastener [#3] to:
IMA22, IMA33, IMA44 = 69 in-lbs (7.8 N-m); IMA55 = 180 in-lbs (20.3 N-m).
3. Apply medium strength thread-locker to the two (2) Fasteners [#8]. Using the two (2) Fasteners [#8] and two (2) Washers [#7], assemble the Bearing Block [#6] onto the actuator finger-tight only, orientated such that the Bearing Block [#6] does not breach the face of the actuator.
4. Insert the Anti-Rotate Shaft [#9] through the Bearing Block [#6] orientated with the shaft's tapped hole facing the working end of the actuator. Light tapping with the dead-blow hammer may be necessary to get the Anti-Rotate Shaft [#9] through the oil wick of the Bearing Block [#6].
5. Manually rotate the thrust rod to retract the actuator as far as the application allows without mechanically stopping or striking any mounting means.
6. Ensure that the Bearing Block Fasteners [#8] are just finger tight allowing the Bearing Block [#6] to float. Align the shallow counterbore of the Anti-Rotate Clamp [#2] with the Anti-Rotate Shaft [#9], engage the shaft into the counterbore. Apply medium strength thread-locker to the Fastener [#1] and assemble through the Anti-Rotate Clamp [#2] and into the Anti-Rotate Shaft [#9].
Torque to: IMA22 = 69 in-lbs (7.8 N-m); IMA33, IMA44, IMA55 = 117 in-lbs (13.2 N-m).
7. Torque the two (2) Bearing Block Fasteners [#8] to:
IMA22 = 117 in-lbs (13.2 N-m) IMA33, IMA44 = 350 in-lbs (39.5 N-m) IMA55 = 840 in-lbs (95.0 N-m).

5: ELECTRICAL INSTALLATION

5.1 Connector Orientation

The IMA is manufactured with both the power and feedback connectors facing forward (toward rod end). The standard Tolomatic connectors are shown in figure 5.2 below. Tolomatic can mount the connectors in the orientation desired by the customer, or be rotated during installation. The Tolomatic IMA Actuator is manufactured to fit many different connector configurations. Many drive manufacturers have specific connectors/pinout/wiring for integrating the Tolomatic IMA Actuator into operation. Reference 5.4 for available configurations. Depending on the connector choice, some connectors may be rotated from -90° to 180° .

For the Tolomatic standard connectors it is not necessary to loosen the screws retaining the connectors. Just carefully rotate to the desired orientation.



NOTE!

Do not apply excessive force while rotating connectors.

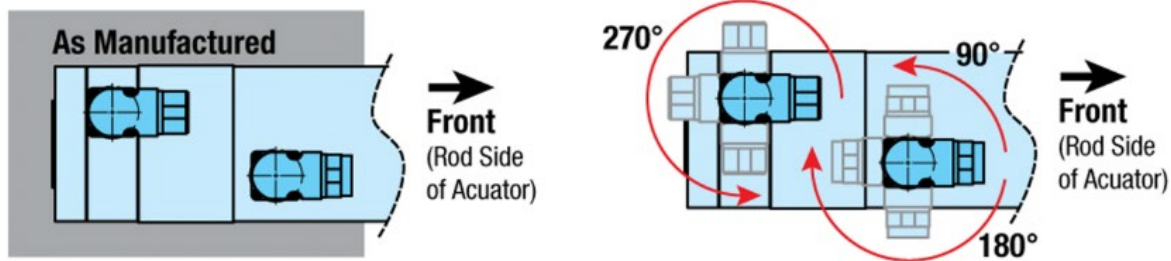

Figure 5.3: Connector rotation. Note that the Tolomatic standard connectors may be rotated from -90° to $+180^\circ$ allowing for cables to connect toward the front (rod end, as manufactured), to either side, both sides, or back of actuator.

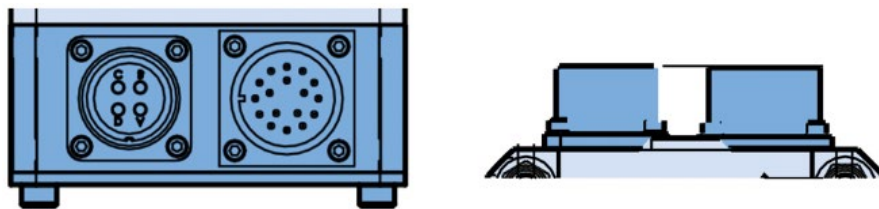

Figure 5.4: Drawing of box mount connectors used on some Tolomatic IMA Actuators.

See individual encoder/connector in section 5.4 for details.

5.2 Feedback Information

IMA actuators may use a digital encoder, multi-turn absolute encoder or a single-pole resolver as the rotary feedback device. The selection of the feedback device is dictated by the drive used to operate the actuator. Each drive has specific requirements for the feedback on the motor. Not all resolver-based drives can use the same resolver, resolver alignment, or relative direction of resolver rotation. Not all encoder-based drives can use the same encoder, encoder alignment or relative direction of encoder rotation. Many drives offer software that allows the entering of parameters or the downloading of "motor data files" that dictate how the feedback must be set up on the motor. Tolomatic can provide many of these "data files" or the proper parameters to enter. Entering motor parameter data to some drives may require assistance from the drive manufacturer.

5.3 Feedback Commutation

When Tolomatic manufactures a Tolomatic IMA Actuator, the proper feedback is selected, mounted, aligned and test run on a servo system drive that is known to be equivalent to the servo system drive that the customer plans to use for confirming proper feedback alignment and operation.

⚠ CAUTION CAUTION!

In any case where it is determined that the feedback has become misaligned, or an drive change is made requiring the feedback to be aligned differently, it is recommended that Tolomatic be contacted and arrangements made to have that procedure performed.

Feedback Type	Offset Alignment	Electrical Degree Tolerance
Hiperface	0 Degrees	+/- 5 Degrees
Hiperface DSL	0 Degrees	+/- 5 Degrees
Endat 2.2	0 Degrees	+/- 5 Degrees
Incremental Encoder	30 Degrees	+/- 5 Degrees
Resolver	90 Degrees	+/- 5 Degrees

5.4 Feedback Commutation Details

Terminology in the industry varies from motor supplier to motor supplier. One example is in the labeling of phases; some suppliers will reference phase R, S and T while others refer to U, V and W. With the differences in terminology visual explanations are used for clarification purposes.

Tolomatic Tolomatic IMA Actuator motors are wired such that as the torque generating current vector progresses from phase U -> V -> W positive rotation is created. Positive rotation is defined as clockwise as viewed from the front face of the actuator. For reference, positive rotation will cause the thrust rod to extend.

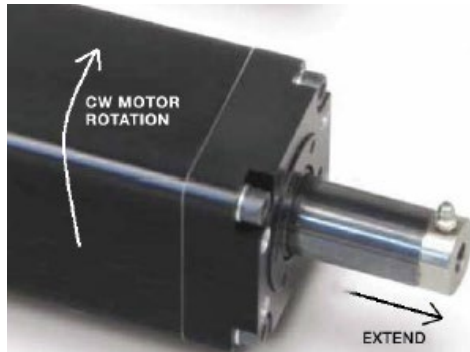

Figure 5.5: Thrust rod movement relative to motor rotation

Absolute Encoder Feedback

The standard commutation offset for the absolute encoders offered in the IMA is set at 0 electrical degrees. This is accomplished by first locking the motor rotor with a current vector from phase U (+) to phase V and W (-), and then sending a set-zero position command to the encoder using appropriate programming tool.

Digital Quadrature Encoder Feedback

The IMA standard feedback device is a digital quadrature encoder. This encoder utilizes differential A and B signals for tracking position and differential index pulse and halls for commutation. The encoder is mounted with a current vector from phase R to phase T, at this commutation angle the index pulse of the encoder is located and the encoder is locked to the shaft of the motor.

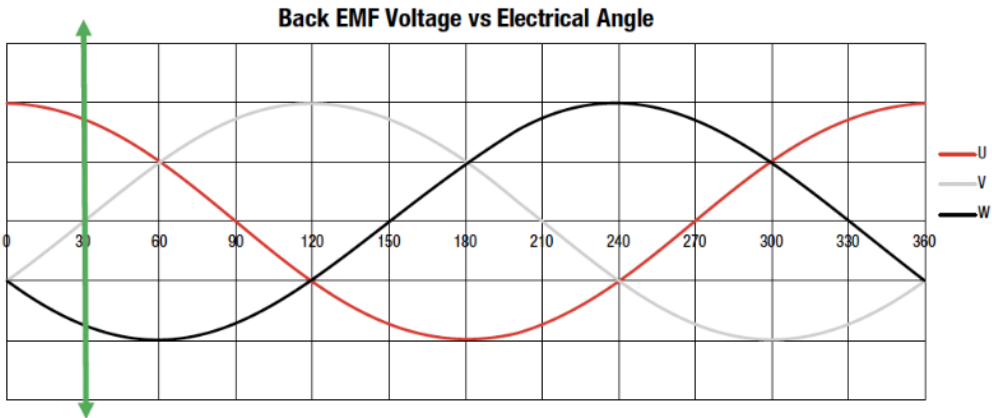

Figure 5.6: Back EMF Voltage vs Electrical Angle

From a manufacturing viewpoint the utilization of a fixed current vector provides the simplest means for aligning a feedback device. Some manufacturers however will reference a motor's back emf when discussing commutation angles. This is due to the ability to quantify via measurement the alignment of a feedback device. With that in mind; when measuring the back emf phase to phase of the winding the following can be verified on an IMA.

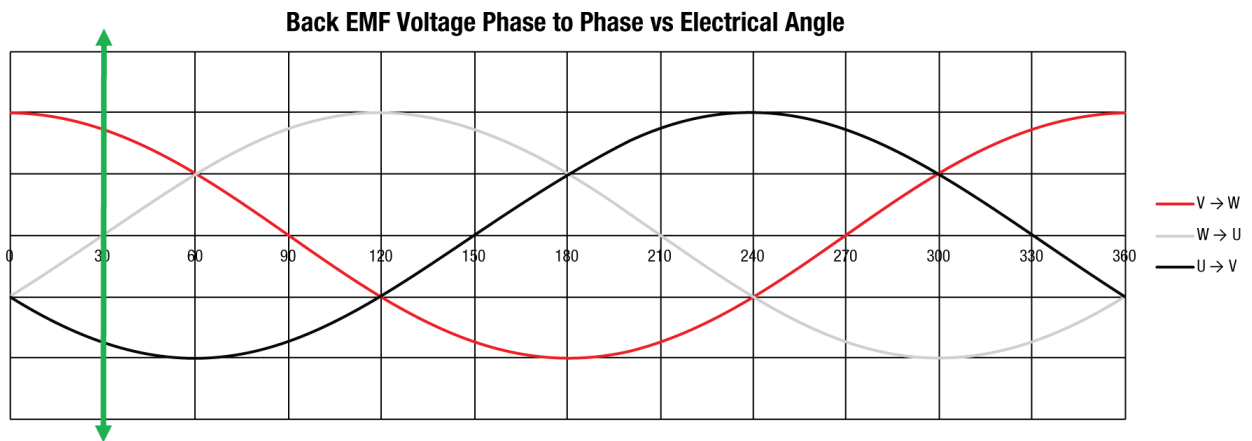

Figure 5.7: Back EMF Voltage Phase to Phase vs Electrical Angle

The quadrature output of the encoder will be such that the rising edge of the A channel leads the rising edge of the B channel with positive rotation as defined in the graph above.

The halls are configured such that the falling edge of the U channel coincides with the index pulse location. The graph at right shows the relationship of the halls to the phase to phase back emf. The halls have an offset of 30 electrical degrees.

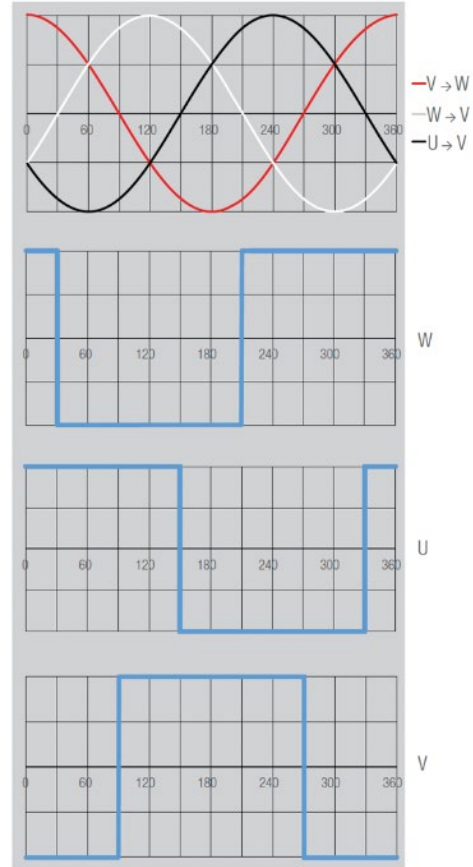

Figure 5.8: Hall Alignment

Resolver Feedback

The Tolomatic IMA Actuator family is also offered with resolver feedback. A resolver must be excited with a sinusoidal input and outputs two signals, commonly referred to as cos and sin. These signals' magnitude and the phase angle relative to the excitation voltage are used by the drive to determine the absolute position (single rotational) of the motor's armature.

These actuators are aligned with a current vector from phase V (+) to phase W (-). At this location, the resolver body is rotated until the cos signal is null, and the sin signal is in phase with the excitation frequency.

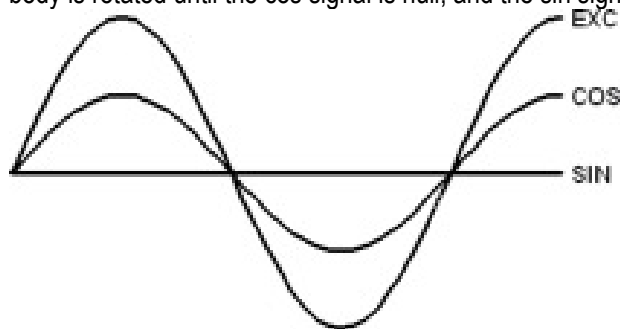

Figure 5.9: Motor rotational position at 0

Direction can be confirmed by rotating the shaft clockwise as viewed from the back, where, after 90 degrees of rotation the cos will now be in phase with the excitation frequency and the sin signal will be null.

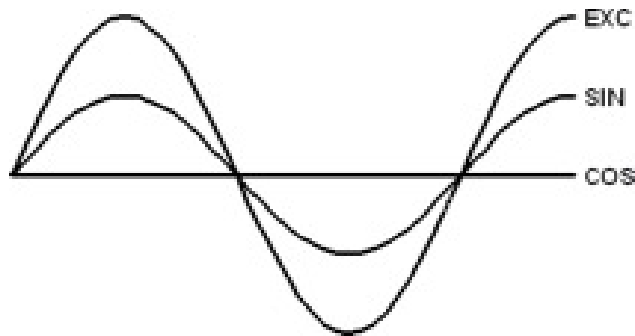

Figure 5.10: Motor rotational position at 90

Servomotor Information:



NOTE!

For performance data and specifications please refer to the Tolomatic [IMA Actuator brochure #2700-4000](#)

5.5 Feedback Specifications

ALL SIZES	
DIGITAL ENCODER	Quantum
Input Voltage	5 VDC (+/-5%)
Input Current	125 mA Typical
Output Circuits	AM26LS31 (RS422 line Driver)
Output Format	Quadrature, 2000 line, with commutation

ALL SIZES	
ABSOLUTE (Dx1A1x)	Stegmann SKM36
Output Type	Hiperface MultiTurn Absolute
Input Voltage	7-12 VDC
Max NL Operating Current	60 mA
Sin/Cos Resolution	128 periods per revolution
Absolute Resolution	4096 revs with 4096 steps per rev

ALL SIZES	
ABSOLUTE (DA2A2x)	Stegmann EKM36
Output Type	Hiperface DSL MultiTurn Absolute
Input Voltage	7-12 VDC
Max NL Operating Current	150 mA
Absolute Resolution	4096 revs with 262, 144 steps per rev

ALL SIZES	
ABSOLUTE (Dx1H1x)	Heidenhain EQN1025
Interface	EnData 2.2 MultiTurn Absolute
Ordering Designation	EnDat01
Input Voltage	3.6 - 14 VDC
Current Consumption Typ	5V: 105mA
Resolution	4096 revs with 8192 steps per rev

IMA22, IMA33, IMA44, IMA55	
RESOLVER	Dynapar BRC
Input Voltage	7 Vrms (+/- 10%)
Excitation Frequency	10 kHz
Max Input Current	40 mA
Transformation Ratio	0.5 (+/-10%)
Impedance [ZRO]	205 Ohms
Impedance [ZRS]	187 Ohms
Impedance [ZSO]	495 Ohms
Impedance [ZSS]	447 Ohms

IMA22, IMA33, IMA44, IMA55	
RESOLVER	Dynapar BRX
Input Voltage	4 Vrms (+/- 5%)
Excitation Frequency	5 kHz
Max Input Current	45 mA
Transformation Ratio	0.5 (+/-10%)
Impedance [ZRO]	129 Ohms
Impedance [ZRS]	120 Ohms
Impedance [ZSO]	461 Ohms
Impedance [ZSS]	427 Ohms

5.6 Thermal Sensor Specifications

Most of the motor windings have an integral normally closed thermal switch. The switch opens at a temperature of 100°C (212° F), which is the windings maximum operating temperature. The Rockwell VPL connector (DA2) will include a Vishay Thermistor for measuring the temperature. The Siemens connector (DS1) will include a PT1000 thermistor for measuring the temperature. The thermal switch/sensor is meant to protect the windings, the actuators continuous operating region must still be obeyed. Cycles that cause the windings temperature to approach 100°C (212° F) will reduce the expected life of the actuator.

All Except DS1 & DA2	
Thermal Switch	
Opens at:	100°C (212°F)
Recommended Current	1.0 ADC
Max Voltage	14 VDC

DS1 (Siemens)	
PT1000 Thermal Transistor	
Make / Model	TE PTFD102B1G0
Nominal Resistance @ 0° C	1000 Ohms
Temp Coefficient of Resistance	3850 ppm
Measuring Current	0.5 mA

DA2 (Rockwell VPL)	
Vishay	
Make/Model	NTCLE213-E3103FLyy
Nominal Resistance @ 0° C	1000 Ohms
Temp Coefficient of Resistance	3850 ppm
Measuring Current	0.5 mA

WARNING!

- Don't exceed rated motor voltage.
- Refer to Servo Drive User Manual for wiring instructions.
- Electrical connections and cabling should receive special attention during component selection and system design when utilizing servo motor controlled systems. The feedback cable consists of twisted pairs of wires in addition to an outer cable shield.
- Improperly wiring the feedback cable can cause unstable operation, incorrect operation or no operation at all.
- In some cases, improper current limits set in the drive, along with incorrect wiring of the feedback cable can lead to damage of the motor.

5.7 Connector Pinouts



NOTE!

NOTE: The IMA is manufactured with your choice of several different connectors to be compliant with popular motor and drive manufacturers. Be sure to also reference all manufacturer material to insure proper connections.

5.7.1 Tolomatic Standard - DT1

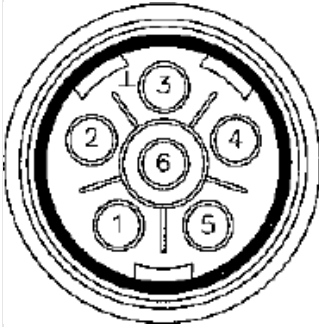

5.7.1.1 Motor Power Connector - DT1xxx	
Manufacturer: Intercontec	
Intercontec Part No.: BEDC 106 MR14 00 1216 000	
Pin	Name
1	Phase R
2	Phase S
3	GND**
4	Phase T
5	* BR+
6	* BR-

**Required

* Connect brake only when present

5.7.1.2 Motor Power Cable Wiring

MV4x (460V) – NO Brake		
Cable Part No.:	CR5 5m: 2733-1611	
	CR10 10m: 2733-1221	
Wire Color	Signal Name	Pin
BLK - 1	Phase R	1
BLK - 2	Phase S	2
GRN/YEL	Ground	3
BLK - 3	Phase T	4

MV4x (460V) – NO Brake		
Cable Part No.:	CR5 5m: 2733-1611	
	CR10 10m: 2733-1221	
Wire Color	Signal Name	Pin
BLK - 1	Phase R	1
BLK - 2	Phase S	2
GRN/YEL	Ground	3
BLK - 3	Phase T	4

MV4x (460V) – WITH Brake		
Cable Part No.:	CR5 5m: 2733-1612	
	CR10 10m: 2733-1222	
Wire Color	Signal Name	Pin
BLK - 1	Phase R	1
BLK - 2	Phase S	2
GRN/YEL	Ground	3
BLK - 3	Phase T	4
BLK (20 AWG)	Brake +	5
WHT (20 AWG)	Brake -	6

MV2x (230V) – WITH Brake		
Cable Part No.:	CR5 5m: 2744-1489	
	CR10 10m: 2744-1222	
Wire Color	Signal Name	Pin
BLK - 1	Phase R	1
BLK - 2	Phase S	2
GRN/YEL	Ground	3
BLK - 3	Phase T	4
RED (18 AWG)	Brake +	5
BLK (18 AWG)	Brake -	6

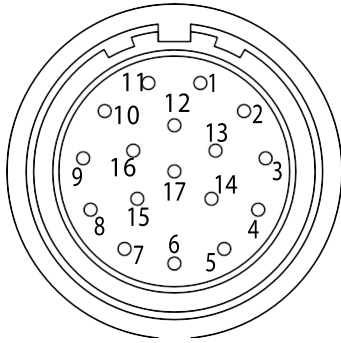

Keyed Center

5.7.1.3 Digital Incremental Connector - DT1 D1x

Manufacturer: Intercontec

Intercontec Part No.: AEDC 113 MR83 00 1215 000

Pin	Name	Pin	Name
1	Temp -	10	A+
2	Temp +	11	I+
3	NC	12	I-
4	Hall U	13	A-
5	Hall U-	14	B+
6	Hall V	15	B-
7	Hall V-	16	+5 Vdc
8	Hall W	17	Com
9	Hall W-		

5.7.1.4 Digital Incremental Cable Wiring (Flying Leads) for DT1 D1x

IMA22, IMA33, IMA44 & IMA55

Cable Part No.:		CR5	5m: 2733-1614
		CR10	10m: 2733-1224
Wire Color		Signal Name	Pin
WHT	Pair 8 (0.34mm ²)	Temp -	1
BRN	Pair 8 (0.34mm ²)	Temp +	2
Shield		Shield	3
GRN	Pair 2	Hall U	4
YEL	Pair 2	Hall U-	5
GRY	Pair 3	Hall V	6
PNK	Pair 3	Hall V-	7
BLK	Pair 4	Hall W	8
VIO	Pair 4	Hall W-	9
GRY/PNK	Pair 5	A+	10
WHT/GRN	Pair 6	I+	11
BRN/GRN	Pair 6	I-	12
RED/BLU	Pair 5	A-	13
RED	Pair 7	B+	14
BLU	Pair 7	B-	15
RED	Pair 1 (0.5mm ²)	+5Vdc	16
BLU	Pair 1 (0.5mm ²)	COM	17

Brake Information: 24 Vdc power is required to release the brake during operation. Ensure that pins 5 and 6 in the power connector are used for the brake.

Thermal Device: Motor equipped with thermal switch at 100C. Tolomatic recommends the use of the thermal switch in order to protect the actuator in higher ambient temperatures.



Keyed Full CCW

5.7.1.5 Resolver - DT1 R1x

Manufacturer: Intercontec

Intercontec Part No.: AEDC 052 MR83 00 1215 000

Pin	Signal Name
1	Excite
2	Excite Lo
3	Cos
4	Cos Lo
5	Sin
6	Sin Lo
7	Temp +
8	Temp -
9	NC
10	NC
11	NC
12	NC

5.7.1.6 Resolver Cable Wiring (Flying Leads) for DT1 R1

IMA22, IMA33, IMA44 & IMA55

Cable Part No.:		CR5	5m: 2733-1613
		CR10	10m: 2733-1223
Wire Color		Signal Name	Pin
RED	Pair 1	Excite	1
GRY	Pair 2	Excite Lo	2
PNK	Pair 2	Cos	3
BLU	Pair 1	Cos Lo	4
VIO	Pair 3	Sin	5
BLK	Pair 3	Sin Lo	6
GRN	Pair 4	Temp +	7
YEL	Pair 4	Temp -	8
	Shield	Shield	9
WHT	(0.5mm ²)	NC	10
	NC	NC	11
BRN	(0.5mm ²)	NC	12

NOTE: NC = no connection

Brake Information: 24 Vdc power is required to release the brake during operation. Ensure that pins 5 and 6 in the power connector are used for the brake.

Thermal Device: Motor equipped with thermal switch at 100C. Tolomatic recommends the use of the thermal switch in order to protect the actuator in higher ambient temperatures.

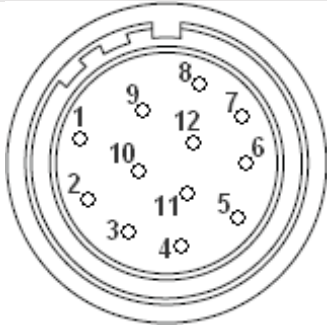

Keyed Full CCW

5.7.1.7 Multi-turn Absolute Encoder - DT1 A1x

Manufacturer: Intercontec

Intercontec Part No.: AEDC 052 MR83 00 1215 000

Pin	Name
1	REFCOS
2	Data+
3	Data-
4	+COS
5	+SIN
6	REFSIN
7	Temp +
8	Temp -
9	NC
10	COM
11	NC
12	Vcc

5.7.1.8 Multi-turn Absolute Encoder Cable Wiring(Flying Leads) for DT1 A1x

IMA22, IMA33, IMA44 & IMA55			
Cable Part No.:		CR5 5m: 2733-1613	
		CR10 10m: 2733-1223	
Wire Color		Signal Name	Pin
RED	Pair 1	REFCOS	1
GRY	Pair 2	Data +	2
PNK	Pair 2	Data -	3
BLU	Pair 1	+ Cos	4
VIO	Pair 3	+ Sin	5
BLK	Pair 3	REFSIN	6
GRN	Pair 4	Temp +	7
YEL	Pair 4	Temp -	8
	Shield	Shield	9
WHT	(0.5mm ²)	COM	10
	NC	NC	11
BRN	(0.5mm ²)	Vcc	12

NOTE: NC = no connection

Brake Information: 24 Vdc power is required to release the brake during operation. Ensure that pins 5 and 6 in the power connector are used for the brake.

Thermal Device: Motor equipped with thermal switch at 100C. Tolomatic recommends the use of the thermal switch in order to protect the actuator in higher ambient temperatures.

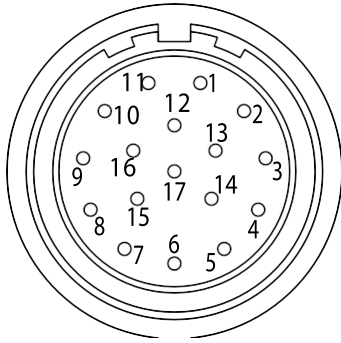

Keyed Center

5.7.1.9 MultiTurn Absolute Encoder - DT1 H1x

Manufacturer: Intercontec

Intercontec Part No.: AEDC 113 MR83 00 1215 000

Pin	Name	Pin	Name
1	Temp -	10	B+
2	Temp +	11	Enc Data +
3	NC	12	Enc Data -
4	NC	13	B -
5	NC	14	A +
6	NC	15	A -
7	NC	16	U P
8	Enc Clk+	17	0 V
9	Enc Clk -		

5.7.1.10 MultiTurn Absolute Encoder Cable Wiring (FlyingLeads) for DT1 H1x

IMA22, IMA33, IMA44 & IMA55			
Cable Part No.:		CR5	5m: 2733-1614
		CR10	10m: 2733-1224
Wire Color		Signal Name	Pin
WHT	Pair 8 (0.34mm ²)	PT 1000	1
RED	Pair 8 (0.34mm ²)	PT 1000	2
YEL/GRN		Shield	3
GRN	Pair 2	NC	4
YEL	Pair 2	NC	5
GRY	Pair 3	NC	6
PNK	Pair 3	NC	7
BLK	Pair 4	Enc Clk +	8
VIO	Pair 4	Enc Clk -	9
GRY/PNK	Pair 5	B +	10
WHT/GRN	Pair 6	Enc Data +	11
BRN/GRN	Pair 6	Enc Data -	12
RED/BLU	Pair 5	B -	13
RED	Pair 7	A +	14
BLU	Pair 7	A -	15
RED	Pair 1 (0.5mm ²)	Up	16
BLU	Pair 1 (0.5mm ²)	0 V	17

Brake Information: 24 Vdc power is required to release the brake during operation. Ensure that pins 5 and 6 in the power connector are used for the brake.

Thermal Device: Motor equipped with thermal switch at 100C. Tolomatic recommends the use of the thermal switch in order to protect the actuator in higher ambient temperatures.

5.7.2 Allen Bradley MP Motor Series - DA1

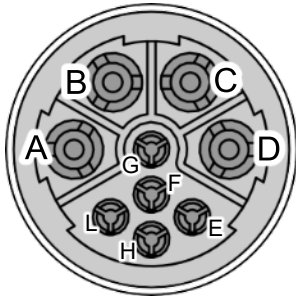

5.7.2.1 Motor Power Connector DA1 xxx	
Manufacturer: Intercontec	
Intercontec Part No.: BECD 091 MR30 00 1216 000	
Pin	Name
A	Phase R
B	Phase S
C	Phase T
D	GND**
E	NC
F	BR+*
G	BR- *
H	NC
L	NC

**Required

*Connect brake only when present

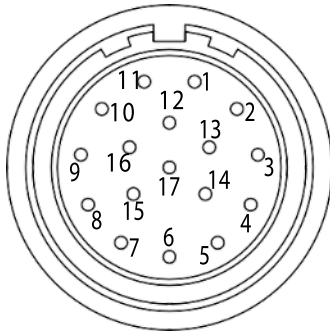

Keyed Center

5.7.2.2 Multi-turn Absolute Encoder Connector DA1 A1			
Manufacturer: Intercontec			
intercontec Part No.: AEDC 113 MR04 00 1215 000			
MV2x (230V)		MV4x (460V)	
Pin	Signal Name	Pin	Signal Name
1	+ SIN	1	+ SIN
2	REFSIN	2	REFSIN
3	+COS	3	+COS
4	REFCOS	4	REFCOS
5	DATA +	5	DATA +
6	DATA -	6	DATA -
7	NC	7	NC
8	NC	8	NC
9	+5 VDC	9	NC
10	COM	10	NC
11	NC	11	+9 VDC
12	NC	12	COM
13	TEMP +	13	TEMP +
14	TEMP -	14	TEMP -
15	NC	15	NC
16	NC	16	NC
17	NC	17	NC

NOTE: NC = no connection

Brake Information: 24 Vdc power is required to release the brake during operation. Ensure that pins F and G in the power connector are used for the brake.

5.7.3 Allen Bradley VP Motor Series - DA2

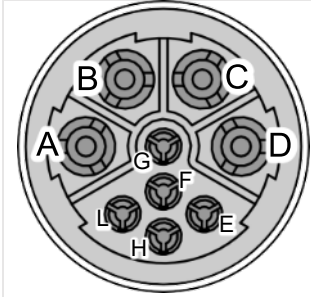

5.7.3.1 Motor Power Connector DA2 xxx	
Manufacturer: Intercontec	
Intercontec Part No.: BECD 091 MR30 00 1216 000	
Pin	Name
A	Phase R
B	Phase S
C	Phase T
D	GND**
E	U + / DSL +
F	BR+*
G	BR- *
H	GND / DSL -
L	NC

**Required

*Connect brake only when present

Brake Information: 24 Vdc power is required to release the brake during operation. Ensure that pins F and G in the power connector are used for the brake.

Thermal Device: Motor equipped with Vishay temperature sensor. Tolomatic recommends the use of the thermal switch in order to protect the actuator in higher ambient temperatures.

⚠ WARNING WARNING!

Encoder temp is not a way to monitor motor temperature. Performance is based on actuator performance.

⚠ WARNING WARNING!

In some cases, improper current limits set in the drive, along with incorrect wiring of the feedback cable can lead to damage of the motor.

5.7.4 Bosch Rexroth MSK Motor Series - DB1

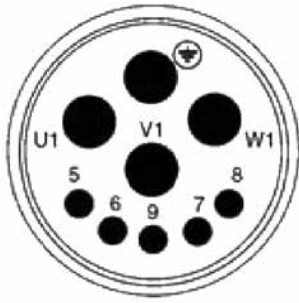
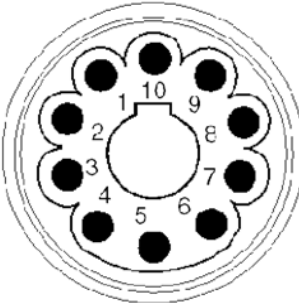
	5.7.4.1 Motor Power Connector - DB1xxx																										
	Manufacturer: Bosch Rexroth Bosch Rexroth Part No.: 911 309687 (RLS1100/C02)																										
<table border="1"> <thead> <tr> <th>Pin</th> <th>Name</th> </tr> </thead> <tbody> <tr> <td>U1</td> <td>Phase R</td> </tr> <tr> <td>V1</td> <td>Phase S</td> </tr> <tr> <td>W1</td> <td>Phase T</td> </tr> <tr> <td>PE</td> <td>GND**</td> </tr> <tr> <td>5</td> <td>Temp +</td> </tr> </tbody> </table>	Pin	Name	U1	Phase R	V1	Phase S	W1	Phase T	PE	GND**	5	Temp +		<table border="1"> <thead> <tr> <th>Pin</th> <th>Name</th> </tr> </thead> <tbody> <tr> <td>6</td> <td>Temp -</td> </tr> <tr> <td>7</td> <td>* BR+</td> </tr> <tr> <td>8</td> <td>* BR-</td> </tr> <tr> <td>9</td> <td>NC</td> </tr> </tbody> </table>	Pin	Name	6	Temp -	7	* BR+	8	* BR-	9	NC			
Pin	Name																										
U1	Phase R																										
V1	Phase S																										
W1	Phase T																										
PE	GND**																										
5	Temp +																										
Pin	Name																										
6	Temp -																										
7	* BR+																										
8	* BR-																										
9	NC																										
*Connect brake only when present **Required																											
	5.7.4.2 Multi-turn Absolute Encoder Connector - DB1 A1x																										
	Manufacturer: Bosch Rexroth Bosch Rexroth Part No.: 911 309733 (RGS1100/C02)																										
<table border="1"> <thead> <tr> <th>Pin</th> <th>Signal Name</th> </tr> </thead> <tbody> <tr> <td>1</td> <td>Vcc</td> </tr> <tr> <td>2</td> <td>Com</td> </tr> <tr> <td>3</td> <td>+COS</td> </tr> <tr> <td>4</td> <td>REFCOS</td> </tr> <tr> <td>5</td> <td>+SIN</td> </tr> </tbody> </table>	Pin	Signal Name	1	Vcc	2	Com	3	+COS	4	REFCOS	5	+SIN		<table border="1"> <thead> <tr> <th>Pin</th> <th>Signal Name</th> </tr> </thead> <tbody> <tr> <td>6</td> <td>REF SIN</td> </tr> <tr> <td>7</td> <td>Data+</td> </tr> <tr> <td>8</td> <td>Data-</td> </tr> <tr> <td>9</td> <td>NC</td> </tr> <tr> <td>10</td> <td>NC</td> </tr> </tbody> </table>	Pin	Signal Name	6	REF SIN	7	Data+	8	Data-	9	NC	10	NC	
Pin	Signal Name																										
1	Vcc																										
2	Com																										
3	+COS																										
4	REFCOS																										
5	+SIN																										
Pin	Signal Name																										
6	REF SIN																										
7	Data+																										
8	Data-																										
9	NC																										
10	NC																										
NOTE: NC = no connection																											

Brake Information: 24 Vdc power is required to release the brake during operation. Ensure that pins 7 and 8 in the power connector are used for the brake.

Thermal Device: Motor equipped with thermal switch at 100C. Tolomatic recommends the use of the thermal switch in order to protect the actuator in higher ambient temperatures.

5.7.5 Control Techniques FM Motor Series - DE1

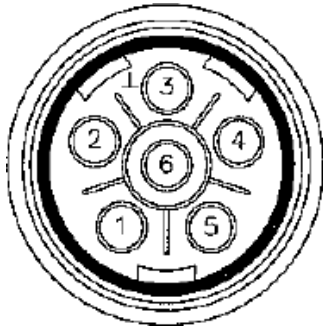

5.7.5.1 Motor Power Connector - DE1xxx

Manufacturer: Intercontec

Intercontec Part No.: BEDC 106 MR14 00 1216 000

Pin	Name	
1	Phase R	
2	Phase S	**Required
3	GND**	
4	Phase T	
5	* BR+	*Connect brake only when present
6	* BR-	

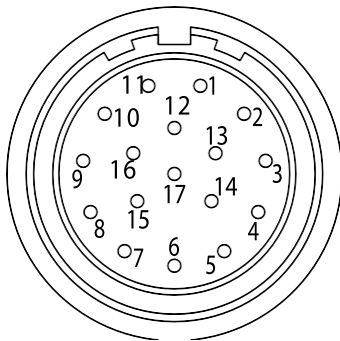

Keyed Center

5.7.5.2 Digital Incremental Connector - DE1 D1x

Manufacturer: Intercontec

Intercontec Part No.: AEDC 113 MR83 00 1215 000

Pin	Name
1	Temp -
2	Temp +
3	NC
4	Hall U
5	Hall U-
6	Hall V
7	Hall V-
8	Hall W
9	Hall W-
10	A+
11	I+
12	I-
13	A-
14	B+
15	B-
16	+5 Vdc
17	Com

Brake Information: 24 Vdc power is required to release the brake during operation. Ensure that pins 5 and 6 in the power connector are used for the brake.

Thermal Device: Motor equipped with thermal switch at 100C. Tolomatic recommends the use of the thermal switch in order to protect the actuator in higher ambient temperatures.



Keyed Full CCW

5.7.5.3 Resolver Connector - DE1 R1x

Manufacturer: Intercontec

Intercontec Part No.: AEDC 052 MR83 00 1215 000

Pin	Signal Name
1	Exc
2	Exc Lo
3	Cos
4	Cos Lo
5	Sin
6	Sin Lo
7	Temp +
8	Temp -
9	NC
10	NC
11	NC
12	NC

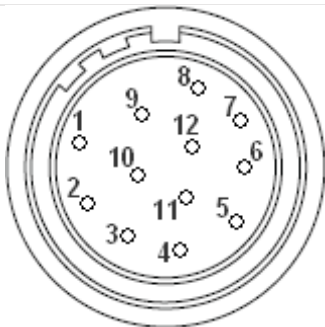

Keyed Full CCW

5.7.5.4 Multi-turn Absolute Encoder - DE1 A1x

Manufacturer: Intercontec

Intercontec Part No.: AEDC 052 MR83 00 1215 000

Pin	Name
1	REFCOS
2	Data+
3	Data-
4	+COS
5	+SIN
6	REFSIN
7	Temp +
8	Temp -
9	NC
10	COM
11	NC
12	Vcc

NOTE: NC = no connection

Brake Information: 24 Vdc power is required to release the brake during operation. Ensure that pins 5 and 6 in the power connector are used for the brake.

Thermal Device: Motor equipped with thermal switch at 100C. Tolomatic recommends the use of the thermal switch in order to protect the actuator in higher ambient temperatures.

5.7.6 Control Techniques NT Motor Series - DE2

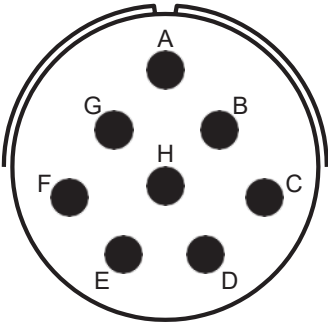
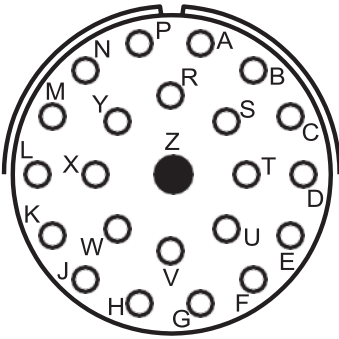
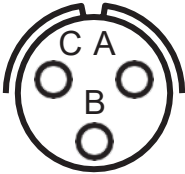
	5.7.6.1 Motor Power Connector - DE2 xxx Manufacturer: Amphenol Amphenol Part No.: PT02E-16-8P(025)																																																		
	<table border="1"> <thead> <tr> <th>Pin</th> <th>Name</th> </tr> </thead> <tbody> <tr> <td>A</td> <td>R</td> </tr> <tr> <td>B</td> <td>S</td> </tr> <tr> <td>C</td> <td>T</td> </tr> <tr> <td>D</td> <td>GND**</td> </tr> <tr> <td>E</td> <td>NC</td> </tr> <tr> <td>F</td> <td>NC</td> </tr> <tr> <td>G</td> <td>NC</td> </tr> <tr> <td>H</td> <td>NC</td> </tr> </tbody> </table>	Pin	Name	A	R	B	S	C	T	D	GND**	E	NC	F	NC	G	NC	H	NC	**Required																															
Pin	Name																																																		
A	R																																																		
B	S																																																		
C	T																																																		
D	GND**																																																		
E	NC																																																		
F	NC																																																		
G	NC																																																		
H	NC																																																		
	5.7.6.2 Digital Incremental Encoder Connector - DE2 D1x Manufacturer: Amphenol Amphenol Part No.: PT02E-16-23P(025)																																																		
	<table border="1"> <thead> <tr> <th>Pin</th> <th>Name</th> </tr> </thead> <tbody> <tr> <td>A</td> <td>Temp+</td> </tr> <tr> <td>B</td> <td>A+</td> </tr> <tr> <td>C</td> <td>A-</td> </tr> <tr> <td>D</td> <td>NC</td> </tr> <tr> <td>E</td> <td>HALL U</td> </tr> <tr> <td>F</td> <td>HALL V</td> </tr> <tr> <td>G</td> <td>HALL W</td> </tr> <tr> <td>H</td> <td>HALL W-</td> </tr> <tr> <td>J</td> <td>NC</td> </tr> <tr> <td>K</td> <td>+5Vdc</td> </tr> <tr> <td>L</td> <td>NC</td> </tr> <tr> <td>M</td> <td>I+</td> </tr> </tbody> </table>	Pin	Name	A	Temp+	B	A+	C	A-	D	NC	E	HALL U	F	HALL V	G	HALL W	H	HALL W-	J	NC	K	+5Vdc	L	NC	M	I+	<table border="1"> <thead> <tr> <th>Pin</th> <th>Name</th> </tr> </thead> <tbody> <tr> <td>N</td> <td>B+</td> </tr> <tr> <td>P</td> <td>B-</td> </tr> <tr> <td>R</td> <td>HALL U-</td> </tr> <tr> <td>S</td> <td>HALL V-</td> </tr> <tr> <td>T</td> <td>COM/Temp-</td> </tr> <tr> <td>U</td> <td>I-</td> </tr> <tr> <td>V</td> <td>NC</td> </tr> <tr> <td>W</td> <td>NC</td> </tr> <tr> <td>X</td> <td>NC</td> </tr> <tr> <td>Y</td> <td>NC</td> </tr> <tr> <td>Z</td> <td>NC</td> </tr> </tbody> </table>	Pin	Name	N	B+	P	B-	R	HALL U-	S	HALL V-	T	COM/Temp-	U	I-	V	NC	W	NC	X	NC	Y	NC	Z
Pin	Name																																																		
A	Temp+																																																		
B	A+																																																		
C	A-																																																		
D	NC																																																		
E	HALL U																																																		
F	HALL V																																																		
G	HALL W																																																		
H	HALL W-																																																		
J	NC																																																		
K	+5Vdc																																																		
L	NC																																																		
M	I+																																																		
Pin	Name																																																		
N	B+																																																		
P	B-																																																		
R	HALL U-																																																		
S	HALL V-																																																		
T	COM/Temp-																																																		
U	I-																																																		
V	NC																																																		
W	NC																																																		
X	NC																																																		
Y	NC																																																		
Z	NC																																																		
	5.7.6.3 Brake Connector* Manufacturer: Amphenol Amphenol Part No.: PT02E-8-3P(025)																																																		
	<table border="1"> <thead> <tr> <th>Pin</th> <th>Name</th> </tr> </thead> <tbody> <tr> <td>A</td> <td>NC</td> </tr> <tr> <td>B</td> <td>* BR+</td> </tr> <tr> <td>C</td> <td>* BR-</td> </tr> </tbody> </table>	Pin	Name	A	NC	B	* BR+	C	* BR-																																										
Pin	Name																																																		
A	NC																																																		
B	* BR+																																																		
C	* BR-																																																		
Separate Brake connector required Connect brake only when present NOTE: NC = no connection																																																			

Brake Information: 24 Vdc power is required to release the brake during operation. Ensure that pins B and C in the power connector are used for the brake.

Thermal Device: Motor equipped with thermal switch at 100C. Tolomatic recommends the use of the thermal switch in order to protect the actuator in higher ambient temperatures.

5.7.7 Lenze MCS Motor Series - DL1

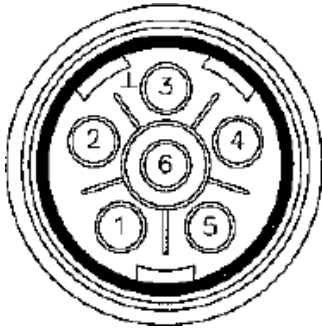

5.7.7.1 Motor Power Connector - DL1xxx

Manufacturer: Intercontec

Intercontec Part No.: BEDC 106 MR14 00 1216 000

Pin	Name	
1	* BR+	*Connect brake only when present
2	* BR-	
3	GND**	**Required
4	Phase R	
5	Phase S	
6	Phase T	

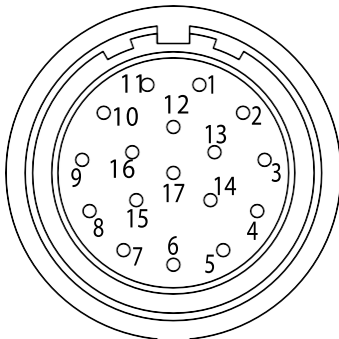

Keyed Center

5.7.7.2 Digital Incremental Encoder Connector - DL1 D1x

Manufacturer: Intercontec

Intercontec Part No.: AEDC 113 MR83 00 1215 000

Pin	Name
1	Temp +
2	I-
3	I+
4	Temp -
5	Hall U+
6	Hall U-
7	+5 Vdc
8	Hall W-
9	Hall W+
10	Com
11	NC
12	B+
13	B-
14	Hall V+
15	A+
16	A-
17	Hall V-

Brake Information: 24 Vdc power is required to release the brake during operation. Ensure that pins 1 and 2 in the power connector are used for the brake.

Thermal Device: Motor equipped with thermal switch at 100C. Tolomatic recommends the use of the thermal switch in order to protect the actuator in higher ambient temperatures.

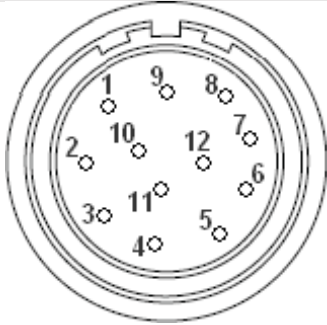

Keyed Center

5.7.7.3 Resolver Connector - DL1 R1x

Manufacturer: Intercontec

Intercontec Part No.: AEDC 052 MR83 00 1215 000

Pin	Name
1	Exc
2	Exc Lo
3	NC
4	Cos
5	Cos Lo
6	Sin
7	Sin Lo
8	NC
9	NC
10	NC
11	Temp +
12	Temp -

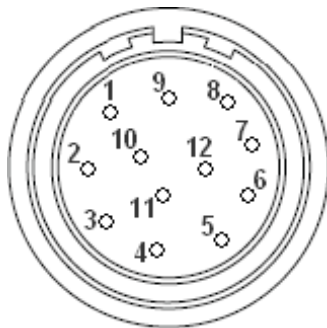

Keyed Center

5.7.7.4 Multi-turn Absolute Encoder Connector - DL1 A1x

Manufacturer: Intercontec

Intercontec Part No.: AEDC 052 MR83 00 1215 000

Pin	Name	Pin	Name
1	+SIN	7	DATA+
2	REFCOS	8	NC
3	+COS	9	REFSIN
4	Vcc	10	NC
5	COM	11	TEMP+
6	DATA-	12	TEMP-

NOTE: NC = no connection

Brake Information: 24 Vdc power is required to release the brake during operation. Ensure that pins 1 and 2 in the power connector are used for the brake.

Thermal Device: Motor equipped with thermal switch at 100C. Tolomatic recommends the use of the thermal switch in order to protect the actuator in higher ambient temperatures.

5.7.8 Siemens 1F Motor Series - DS1

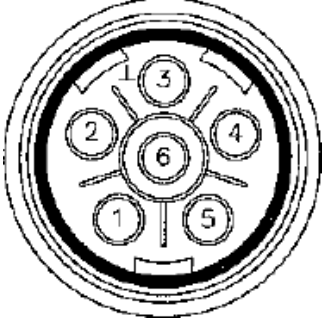
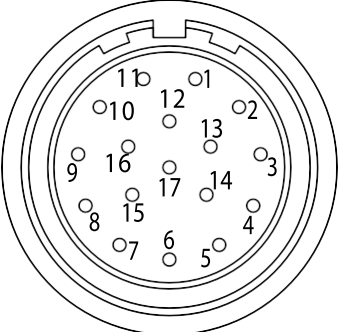
	5.7.8.1 Motor Power Connector - DS1 xxx Manufacturer: Intercontec Intercontec Part No.: BEDC 106 MR14 00 1216 000																																						
	<table border="1"> <thead> <tr> <th>Pin</th> <th>Name</th> </tr> </thead> <tbody> <tr> <td>1</td> <td>Phase R</td> </tr> <tr> <td>2</td> <td>Phase S</td> </tr> <tr> <td>3</td> <td>GND**</td> </tr> <tr> <td>4</td> <td>*BR +</td> </tr> <tr> <td>5</td> <td>*BR -</td> </tr> <tr> <td>6</td> <td>Phase T</td> </tr> </tbody> </table>	Pin	Name	1	Phase R	2	Phase S	3	GND**	4	*BR +	5	*BR -	6	Phase T	**Required *Connect brake only when present																							
Pin	Name																																						
1	Phase R																																						
2	Phase S																																						
3	GND**																																						
4	*BR +																																						
5	*BR -																																						
6	Phase T																																						
 <p>Keyed Center</p>	5.7.8.2 MultiTurn Absolute Encoder Connector - DS1 H4x Manufacturer: Intercontec Intercontec Part No.: AEDC 113 MR83 00 1215 000																																						
	<table border="1"> <thead> <tr> <th>Pin</th> <th>Name</th> </tr> </thead> <tbody> <tr> <td>1</td> <td>A +</td> </tr> <tr> <td>2</td> <td>A -</td> </tr> <tr> <td>3</td> <td>Data +</td> </tr> <tr> <td>4</td> <td>NC</td> </tr> <tr> <td>5</td> <td>Clock</td> </tr> <tr> <td>6</td> <td>NC</td> </tr> <tr> <td>7</td> <td>0 V (M Enc)</td> </tr> <tr> <td>8</td> <td>PT 1000</td> </tr> <tr> <td>9</td> <td>PT 1000</td> </tr> </tbody> </table>	Pin	Name	1	A +	2	A -	3	Data +	4	NC	5	Clock	6	NC	7	0 V (M Enc)	8	PT 1000	9	PT 1000	<table border="1"> <thead> <tr> <th>Pin</th> <th>Name</th> </tr> </thead> <tbody> <tr> <td>10</td> <td>Up (P Enc)</td> </tr> <tr> <td>11</td> <td>B +</td> </tr> <tr> <td>12</td> <td>B -</td> </tr> <tr> <td>13</td> <td>Data -</td> </tr> <tr> <td>14</td> <td>Clock -</td> </tr> <tr> <td>15</td> <td>Sensor 0 V (M Sense)</td> </tr> <tr> <td>16</td> <td>Sensor Up (P Sense)</td> </tr> <tr> <td>17</td> <td>NC</td> </tr> </tbody> </table>	Pin	Name	10	Up (P Enc)	11	B +	12	B -	13	Data -	14	Clock -	15	Sensor 0 V (M Sense)	16	Sensor Up (P Sense)	17
Pin	Name																																						
1	A +																																						
2	A -																																						
3	Data +																																						
4	NC																																						
5	Clock																																						
6	NC																																						
7	0 V (M Enc)																																						
8	PT 1000																																						
9	PT 1000																																						
Pin	Name																																						
10	Up (P Enc)																																						
11	B +																																						
12	B -																																						
13	Data -																																						
14	Clock -																																						
15	Sensor 0 V (M Sense)																																						
16	Sensor Up (P Sense)																																						
17	NC																																						

Brake Information: 24 Vdc power is required to release the brake during operation. Ensure that pins 4 and 5 in the power connector are used for the brake.

Thermal Device: Motor equipped with a PT1000 temperature sensor.

⚠ WARNING WARNING!

Encoder temp is not a way to monitor motor temperature. Performance is based on actuator performance.

⚠ WARNING WARNING!

In some cases, improper current limits set in the drive, along with incorrect wiring of the feedback cable can lead to damage of the motor.

6: IMA OPERATION AND START UP CONSIDERATIONS

6.1 Attaching Cables & Homing / Mechanical Travel Limits

1. Carefully align each cable connector with the respective motor connector.
2. Fully seat the feedback and power connectors.
3. Verify continuity and functionality of the thermal switch signals, TS+ and TS-. These signals are transmitted through the cables that connects the motor to its motion control system.
4. When homing the Tolomatic IMA Actuator avoid excessive force. During homing do not exceed 20% of continuous thrust or speeds of 0.1 in/sec (2.5 mm/sec). **Exceeding these recommendations can cause permanent damage to the actuator.** Careful attention should always be taken to prevent exceeding the physical limits of the actuator.

CAUTION!

The mechanical travel limits of the actuator must be verified to ensure the actuator will not reach an internal hard limit during normal operation. The end of stroke bumpers should NOT be engaged during normal programmed servo actuator operation.

6.2 Brake

WARNING!

In all vertical application an un-powered Tolomatic IMA Actuator will require a brake to maintain position. Tolomatic recommends that the nominal back drive force specification (listed on page 52) be used for reference only. Back drive force is subject to change throughout the life of the actuator, due to mechanical break in, ambient temperature, and duty cycle variation.

A brake can be used with the actuator to keep it from backdriving, typically in vertical applications. A brake may be used for safety reasons or for energy savings allowing the actuator to hold position when un-powered.



NOTE!

The optional Spring-Applied / Electronically-Released Brake typically requires 24 V power. The brake is spring engaged and electrically released.

CAUTION!

DO NOT attempt to operate the actuator with the brake applied. Allowing the actuator to operate with the brake applied may cause serious damage to the actuator and/or the brake. Do not use the brake to support heavy loads while an operator is under the load. Provide another means to lock the load in position. The brake is a spring applied friction mechanism and does not provide a positive lock.

Protecting the brake from voltage transients in applications where it will be engaged and disengaged frequently is advised. The use of a rectifying diode and zener diode will provide optimal protection against these transients.

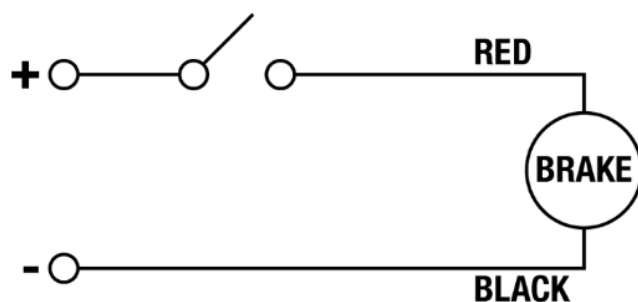

Figure 6.1: Fastest Engage / Disengage time, least protection

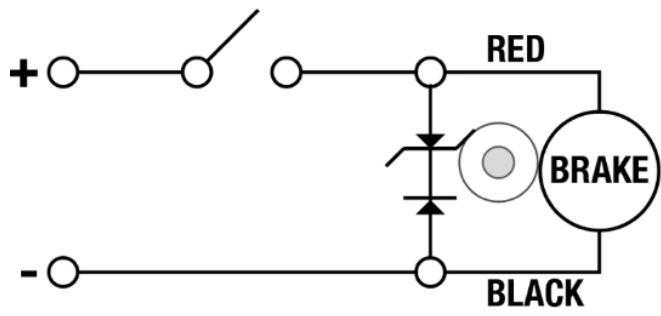

Figure 6.2: Increased Engage / Disengage time, best protection

7: IMA REPAIR AND MAINTENANCE

⚠ WARNING WARNING!

Before starting any maintenance activities, make sure that the supply power is shut OFF.

7.1 Lubrication

NEW UNIT: All Tolomatic IMA Actuators have been lubricated at the factory and are ready for installation. If the actuator is placed in storage for more than 1 year after it is received, the actuator should be lubricated through the lubrication port on the thrust rod with Mobilith SHC220 #2744-1016 (QUANTITY: IMA33: 3.0 g; IMA44: 5.0 g; IMA55: 7.0 g and cycled at least two full strokes prior to running in a loaded condition.

Lubrication needs in a given application are dependent on multiple factors:

- Ambient temperature of environment
- Application schedule:
 - Number of extend/retract (long moves) per minute
 - Number of extend/retract (short moves) per minute
 - Actuator thrust rod force required

⚠ CAUTION CAUTION!

Do not over-fill with grease

Overfilling will cause a reduction in performance, excessive heat buildup and potential premature failure.

7.2 Periodic Maintenance

PERIODIC MAINTENANCE: In typical applications, it is recommended to re-lubricate the Tolomatic IMA Actuators using the following calculations.

BALL SCREW

Where:	
P_{IMA} = IMA Power Output	K_p = Power Factor
V_{RMS} = RMS Velocity (<i>in/sec</i>)	P_C = Power Level
T_{RMS} = RMS Thrust (<i>lbf</i>)	t_l = Lubrication Interval (<i>hours</i>)

Step 1: Calculate actuator Power Output

$$P_{IMA} = V_{RMS} \times T_{RMS} \times 0.113 \text{ (watts)}$$

Step 2: Select the appropriate actuator power level P_C

	33	44	55
P_C	105	185	240

Step 3: Calculate the Power Factor

$$K_p = \frac{P_C}{P_{IMA}}$$

Step 4: The lubrication interval (t_l) for a given cycle is then calculated as:

$$t_l = 1,000 \text{ (hours)} = K_p < 1$$

$$t_l = 9,000 \text{ (hours)} = K_p < 1$$

- Re-lubricate with Mobilith SHC220 #2744-1016 (QUANTITY: IMA33: 3.0 g; IMA44: 5.0 g; IMA55: 7.0 g) into the grease zerk located on the rod end.
- IMA22 ball-screw does not require republication.

BALL SCREW LUBRICATION (Example Calculation)

Cycle Details:

Product: IMA33 BN

V_{RMS} : 1.66 in/sec

T_{RMS} : 400 lbf

T_{MAX} : 400 lbf

Step 1: Calculate your actuator's power output.

$$P_{IMA} = 1.66 \text{ in/sec} \cdot 400 \text{ lbf} \cdot 0.113 = 75 \text{ (watts)}$$

Step 2: Select the appropriate actuator power level. P_C

$$P_C = 105 = \text{IMA33BN}$$

Step 3: Calculate the Power Factor.

$$K_P = \frac{105}{75} = 1.4$$

Step 4: The lubrication interval (t_i) for a given cycle is then calculated as:

$$t_i = 9000 \text{ (hours)} = K_P > 1$$

ROLLER SCREW

For optimal performance and rated life, periodic re-lubrication is required.

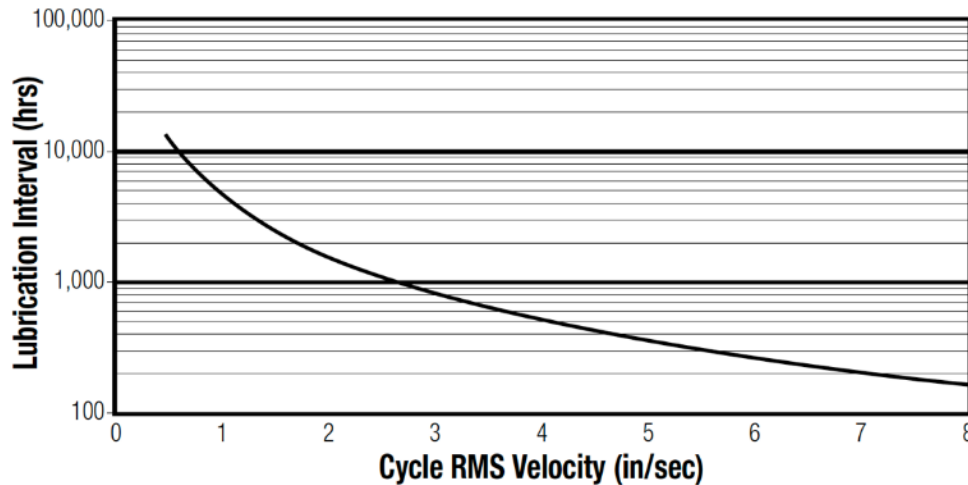

Figure 7.1: Roller Screw Lubrication Interval Graph

Where:	K_{Co} = Screw Static Load Factor
t_{BL} = Basic Lubrication Interval (hours)	T_{PEAK} = Actuator Peak Thrust Rating
V_{RMS} = RMS Velocity (in/sec)	P_e = Cycle Equivalent Load
K_T = Thrust Correction Factor	t_L = Lubrication Interval (hours)

Step 1: Select the Basic Lubrication Interval (t_{BL}) based on the cycles RMS Velocity (V_{RMS}).

$$t_{BL} = 4500 \times (V_{RMS})^{-1.57} \text{ (hours)}$$

Step 2: Determine the Thrust Correction Factor (K_T) based on the ratio of the Actuator Peak Thrust Rating (T_{PEAK}) to the Cycle Equivalent Load (P_e).

$$K_T = K_{Co} \left(\frac{T_{PEAK}}{P_e} \right) - 0.15$$

	33RN05	33RN10	44RN05	44RN10	55RN05	55RN10
K_{Co}	0.24	0.44	0.26	0.40	0.31	0.84



IMPORTANT NOTE: K_T can not be greater than 1.

Step 3: The Lubrication Interval (t_L) for a given cycle is then calculated as:

$$t_L = t_{BL} \times K_T \text{ (hours)}$$

Re-lubricate with Tolomatic Grease #2744-9099 into the grease zerk located on the rod end.

QUANTITY						
IMA33	2.5 + [0.010 x L (mm)]	g	IMA33	0.09 + [0.009 x L (in)]	oz	
IMA44	4.8 + [0.010 x L (mm)]	g	IMA44	0.17 + [0.009 x L (in)]	oz	
IMA55	6.6 + [0.019 x L (mm)]	g	IMA55	0.23 + [0.017 x L (in)]	oz	
L=stroke length (mm or in)						

ROLLER SCREW LUBRICATION (Example Calculation)

Cycle Details:

Product: IMA33 RN05

V_{RMS} : 1.66 in/sec

T_{PEAK} : 1700 lbf

P_e : 400 lbf

Step 1: Select the Basic Lubrication Interval (t_{BL}) based on the cycles RMS Velocity (V_{RMS}).

$$t_{BL} = 4500 \times (1.66 \text{ in/sec})^{-1.57} = 2019 \text{ (hours)}$$

Step 2: Determine the Thrust Correction Factor (K_T) based on the ratio of the Actuator Peak Thrust Rating (T_{PEAK}) to the Cycle Equivalent Load (P_e).

$$K_T = 0.24 \left(\frac{1700 \text{ lbf}}{400 \text{ lbf}} \right) - 0.15 = 0.87$$

	33RN05	33RN10	44RN05	44RN10	55RN05	55RN10
K_{Co}	0.24	0.44	0.26	0.40	0.31	0.84



IMPORTANT NOTE: K_T can not be greater than 1.

Step 3: The Lubrication Interval (t_L) for a given cycle is then calculated as:

$$t_L = 2019 \text{ (hours)} \times 0.87 = 1757 \text{ (hours)}$$



NOTE!

Tolomatic recommends validating the output force after 100 000 cycles and on an annual basis thereafter.

It is recommended that the actuator be visually inspected after initial startup and twice a year thereafter, specifically checking for uneven wear or discoloration of the thrust rod which may indicate side loading and lead to premature seal failure. Contact the nearest Tolomatic service center with any concerns or questions.



Figure 7.1: A standard grease zerk allows periodic relubrication for Tolomatic IMA Actuators. This can be done without removing the actuator from its installation.

7.3 Procedure for lubrication



NOTE!

Before starting any maintenance activities, confirm Tolomatic IMA Actuator is in full retract position and supply power is shut off.

1. Ensure Tolomatic IMA Actuator is in full retract position
2. Using a standard grease gun, apply the grease (amount determined in previous section) into the grease Zerk on the rod end of the actuator:
3. Re-apply power to the Tolomatic IMA Actuator
4. Complete five full extend / full retract moves of the Tolomatic IMA Actuator at low speed / low force to properly distribute the grease



CAUTION!

Do not over-fill with grease

Overfilling will cause a reduction in performance, excessive heat build up and potential premature failure.

7.4 Tolomatic IMA Maintenance and Repair

The only user serviceable component of the IMA actuator is the rod wiper.

Further disassembly of the IMA is not recommended. IMA actuators should be returned to Tolomatic for evaluation and repair.

Contact Tolomatic for instructions on how to return the IMA actuator for evaluation.

**For IMA33 & 44
manufactured
before July 16, 2013**

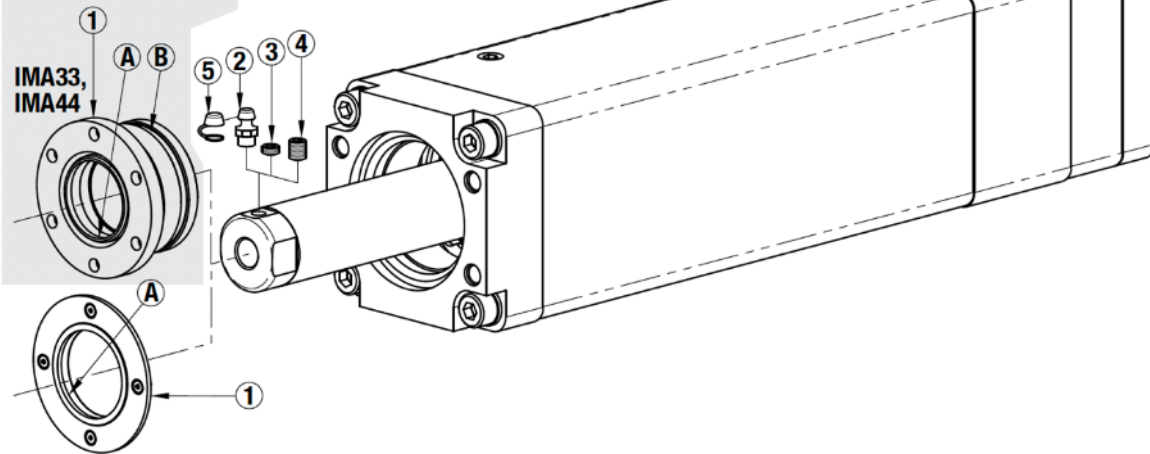

Parts Listing				
Item	Part No.	Description		
1.	2733-9003	IMA33 Kit, Bearing / Wiper		
	2744-9003	IMA44 Kit, Bearing / Wiper		
		IMA33	IMA44	
	A.	2115-1030	2744-1003	Wiper
	B.	1014-1037	1019-1037	O-Ring
1.	2722-9146	IMA22 Kit, Pilot Ring / Wiper		
	2733-9146	IMA33 Kit, Pilot Ring / Wiper		
	2744-9146	IMA44 Kit, Pilot Ring / Wiper		
	2755-9146	IMA55 Kit, Pilot Ring / Wiper		
		IMA22	IMA33	IMA44
A.	2552-1132	2115-1030	2744-1003	2140-1030
2.	0100-1601	Zerk, Fitting, 1/4-28		
3.	2309-1055	Set Screw, 1/4-28 (Flush zerk replacement)		
4.	2744-1214	Grease Fitting Plug, 1/4-28 (leak-proof)		
5.	2744-1213	Grease Zerk Cap (leak-resistant)		

7.5 Wiper Maintenance

In extreme environments it may be necessary to replace the rod bearing/wiper assembly.

IMA33 & 44 manufactured before July 16, 2013

The rod bearing/wiper assembly can be removed, after grease zerk removal, by threading it out of the front plate using a spanner wrench. A new rod bearing/wiper assembly can then be reinstalled. To have this service performed for you, contact Tolomatic.

IMA22, 33, 44 & 55 Manufactured after July 16, 2013

IMA22, 33, 44 and 55 have a replaceable wiper only. The wiper can be replaced by removing the zerk and the screws from the pilot ring.

⚠ WARNING **WARNING!**

There is a possibility that base oil may leak from the Grease Zerk (#2). In contamination sensitive applications replace Grease Zerk (#2) with a leak-proof Grease Fitting Plug (#4), or add a leak-resistant Grease Zerk Cap (#5) to cover Grease Zerk (#2).

7.5 Storage Recommendations

Pay attention to the following when storing the actuator:

- Perform repairs, maintenance and inspections before storing equipment to ensure that the equipment is in good working order.
- Ensure that storage will not damage external surface creating pits, scratches or crevices.
- Make sure the equipment is placed in a suitable storage position (horizontal) to prevent damage to the connectors and electronics.
- Protect the feedback device, which is located at the blind (non-rod end) of the Tolomatic IMA Actuator.
- Store in clean and dry environment.
- After six (6) months of storage it is recommended to cycle two complete strokes of the Tolomatic IMA Actuator to redistribute the internal lubricants.
- It is also recommended to cycle the Tolomatic IMA Actuator two complete strokes before placing in service.
- If stored for a period longer than 2 years without use it may be necessary to replace the lubricants. Follow the instructions in section 7.2 or return to Tolomatic for this maintenance.
- Storage temperature is -25°C to +60°C (-13°F to +140°F).

APPENDIX A: SPECIFICATIONS



NOTE!

NOTE Please see Tolomatic [IMA Actuator brochure #2700-4000](#) for complete information on performance data. Use 3D CAD files (available at www.tolomatic.com) for critical dimensions.

A.1 Actuator Specifications

Performance and Mechanical Specifications



NOTE!

NOTE Please see Tolomatic [IMA Actuator brochure #2700-4000](#) for complete information on performance and mechanical specifications.

A.2 Motor Specifications:



NOTE!

NOTE Please see Tolomatic [IMA Actuator brochure #2700-4000](#) for complete information on motor specifications.

A.3 Brake Specifications



NOTE!

NOTE Please see Tolomatic [IMA Actuator brochure #2700-4000](#) for complete information on brake specifications.

A.4 Speed vs Thrust Graphs



NOTE!

NOTE Please see Tolomatic [IMA Actuator brochure #2700-4000](#) for complete information on performance data. Refer to the charts for the continuous and peak thrust and speed capabilities of the screw selections.



NOTE!

NOTE: IMA integrated motor rod-style actuators are designed to move guided and supported loads and are not designed for applications that require significant side loading. Please contact Tolomatic at 1-800-328-2174 or 763-478-8000 for details regarding side loading capabilities.

PEAK REGION is the maximum performance capabilities of the actuator system. Higher peak thrusts are achievable by servo motor actuator systems, so please consult Tolomatic before exceeding catalog rating. CONTINUOUS REGION is defined as the RMS thrust and velocity limit that is derived from the thermal limits of the actuator system to achieve the dynamic load rating of the screw. (Example: Extend and retract under force 100% of the time with no dwells.)

$$\mathbf{T}_{\text{RMS}} = \sqrt{\frac{\sum (\mathbf{T}_i^2 \times \mathbf{t}_i)}{\sum (\mathbf{t}_i)}}$$

$$\mathbf{V}_{\text{RMS}} = \sqrt{\frac{\sum (\mathbf{V}_i^2 \times \mathbf{t}_i)}{\sum (\mathbf{t}_i)}}$$

Where:

\mathbf{T}_{RMS} = RMS Thrust

\mathbf{V}_{RMS} = RMS Velocity

\mathbf{T}_i = Thrust during interval i

\mathbf{V}_i = Velocity during interval i

\mathbf{t}_i = Time interval i

A.5 Calculating RMS Thrust and Velocity for Continuous Duty:

Servo motor actuator systems have two speed / thrust curves: one for continuous (severe duty) and another for peak region (intermittent or operating). The root mean square (RMS) thrust & velocity is based on the application duty cycle and must fall within the continuous duty region of the actuator system. The application maximum thrust

& velocity must fall within the peak region of the actuator system. Higher peak thrusts are achievable by the actuator system, so please consult Tolomatic before exceeding catalog ratings. Use the following formulas when calculating the RMS thrust & velocity. When selecting a servo motor actuator system, it is recommended to add a margin of safety of 15% to the thrust and velocity required to move the load.

■ A.6 Critical Speed



NOTE!

NOTE Please see Tolomatic [IMA Actuator brochure #2700-4000](#) for complete information on motor specifications.

■ A.7 Ball & Roller Screw Life



NOTE!

NOTE Please see Tolomatic [IMA Actuator brochure #2700-4000](#) for complete information on motor specifications.

■ A.8 Standard thermal switch specifications

The motor windings have an integral normally closed thermal switch or resistance based temperature measurement device. These devices must be integrated with the robot controller. The switch opens at a temperature of 212° F (100°C), which is the windings maximum operating temperature. The thermal switch is meant to protect the windings, the actuators continuous operating region must still be obeyed. Operation that causes the windings temperature to approach 212° F (100°C) will reduce the expected life of the actuator.

APPENDIX B: TROUBLESHOOTING PROCEDURE

SYMPTOM	POTENTIAL CAUSE	SOLUTION
No response from actuator	Controller / Drive not enabled	Enable Controller/Drive
	Controller / Drive faulted	Reset the Controller/Drive
	Improper / Failed wiring	Check the wiring
Actuator is enabled but is not operating or is operating erratically	Feedback cable may be damaged	Test the feedback cable
	Feedback wiring may be incorrect	Verify feedback wiring
Actuator is operating but is not up to rated speeds/force	Motor phases are wired incorrectly or in incorrect order	Verify correct wiring of motor armature
	Drive may be improperly tuned	Check all gain settings
	Drive may be set up improperly for Tolomatic IMA Actuator used	Check drive settings for number of poles, voltage, current, resistance, inductance, inertia, etc.
	Feedback is improperly aligned	Contact Tolomatic
Actuator cannot move	Force is too large for the capacity of the actuator or too much friction is present	Verify force requirements
	Excessive side load	Verify correct operation
	Misalignment of output rod to application	Verify correct alignment
	Drive has too low of current capacity or is limited to tool low of current capacity	Verify correct drive and settings
	Actuator has crashed into hard stop	Disconnect from load and manually move away from hard stop. If problem persists, contact Tolomatic for service.
Actuator housing moves or vibrates when shaft is in motion	Loose mounting	Check actuator mounting
	Drive is improperly tuned – wrong gain settings	Tune drive
Actuator is overheating	Duty cycle is higher than actuator ratings	Verify duty cycle is within continuous ratings
	Drive is poorly tuned, causing excessive unnecessary current to be applied to motor	Check gain settings
	Actuator low or out of grease	Re-lubricate (if applicable)

APPENDIX C: WARRANTY

■ C.1 Warranty

Warranty and Limitation of Liability

Tolomatic's complete terms and conditions can be found here <https://www.tolomatic.com/info-center/resource-details/terms-and-conditions>

Limited Warranty

Tolomatic warrants that at the time of delivery, Products shall be in good condition, free from defects in material and workmanship and that Products made to order shall conform to applicable drawings or specifications as referenced in the quotation or accepted purchase order ("Product Warranty"). The Product Warranty shall expire one year from date of shipment (the "Warranty Period"). Tolomatic warrants that Buyer shall acquire good title to the Products free from third party rights. These warranties are given only to Buyer and not to any third party. The Product Warranty excludes any defects or non-conformance resulting (wholly or in part) from: (i) accidental damage, mishandling, incorrect installation, negligence or other circumstances arising after delivery; (ii) the repair or alteration of the Product by any party other than Tolomatic or its authorized representative; (iii) the failure by Buyer to provide a suitable storage, use, or operating environment for the Products; (iv) Buyer's use of the Products for a purpose or in a manner other than that for which they were designed; and (v) other abuse, misuse or neglect of the Products by Buyer or any third party.

The Product Warranty excludes any Products not manufactured by Tolomatic. Insofar as any Products are manufactured by third parties, Tolomatic shall, insofar as it can, pass to the Buyer the benefit of all warranties given by the supplier of such Products.

The Product Warranty shall be limited to defects of which Tolomatic is notified within twenty-one (21) days from the date of shipment to Buyer or, in the event of latent defects, within twenty-one (21) days of the defect being discovered and provided that such notice is received within the Warranty Period. As sole remedy for the breach of the warranty in paragraph (a) above, provided that (if required by Tolomatic) all non-conforming Products are returned to Tolomatic at Buyer's cost, and provided that Tolomatic confirms the defect or non-conformance, Tolomatic shall at its option (i) replace or repair the defective or non-conforming items, or correct any defective work or non-conformance, or (ii) refund to Buyer the original purchase price of the defective or non-conforming item and reimburse to Buyer any transportation and insurance charges incurred by Buyer.

Any claim by Buyer against Tolomatic alleging the breach of the Product Warranty must be commenced within twelve (12) months following the date of the alleged breach.

In the event the parties disagree whether or not a breach of the Product Warranty has occurred, Tolomatic may (but shall not be obliged to) undertake any repairs or replacement requested by Buyer pending final settlement of the matter. If it is determined that no such breach has occurred, Buyer shall pay Tolomatic upon demand the reasonable price of the repairs, corrections, or replacements made by Tolomatic including allowances for overheads and a reasonable profit margin.

THE WARRANTIES EXPRESSLY MADE UNDER THESE TERMS ARE EXCLUSIVE AND GIVEN IN LIEU OF ALL OTHER REPRESENTATIONS, WARRANTIES AND COVENANTS THAT MAY BE IMPLIED BY LAW, BY CUSTOM OF TRADE, BY THESE TERMS, BY THE PURCHASE ORDER OR OTHERWISE WITH RESPECT TO THE PRODUCTS. TO THE FULL EXTENT PERMITTED BY LAW, TOLOMATIC DISCLAIMS AND BUYER WAIVES ALL SUCH REPRESENTATIONS, WARRANTIES AND COVENANTS INCLUDING BUT NOT LIMITED TO, ANY IMPLIED WARRANTIES OF MERCHANTABILITY, FITNESS FOR A PARTICULAR PURPOSE OR NON-INFRINGEMENT OF THIRD PARTY INTELLECTUAL PROPERTY RIGHTS. BUYER'S SOLE REMEDY FOR BREACH OF WARRANTY IS STATED IN PARAGRAPH (d) ABOVE.

No Products shall be returned without Tolomatic's prior written consent. Products which Tolomatic consents to have returned shall be shipped by Buyer at Buyer's risk and expense, freight prepaid, to such location as Tolomatic designates.

Limitation of Liability

Tolomatic shall in no event be liable to Buyer or any third party, whether in contract, tort (including negligence),

misrepresentation, strict liability or otherwise, for any incidental, punitive, consequential, indirect or special damages, including any loss of profits or savings or anticipated profits or savings, loss of data, loss of opportunity, loss of reputation, loss of goodwill or business or potential business, however caused, even if Tolomatic has been advised of the possibility of such damages in advance.

Under no circumstances shall Tolomatic's liability to Buyer in connection with any purchase order or Products supplied to Buyer exceed an amount equal to the amount paid by Buyer for such Products.

Buyer agrees and understands that it is solely Buyer's responsibility to ensure that Products are suitable for Buyer's requirements and for the environment, facilities or machinery for which they are intended by Buyer or by its end-customer to be fitted or used. Even if Tolomatic is advised of Buyer's intended use, Tolomatic makes no representation or warranty that the Product will be suitable for that purpose. Any technical advice furnished by Tolomatic relating to the intended use of the Products is given for information only and Tolomatic assumes no obligation or liability for the advice given or the results obtained. Except insofar as specifications or drawings form part of a purchase order and the Product Warranty, to the full extent permitted by law, Tolomatic disclaims and Buyer waives all representations, warranties and covenants that may be implied from the provision by Tolomatic of technical advice or information about Product. All such advice and information are accepted by Buyer at its risk. Insofar as any liability or warranty of Tolomatic cannot be limited or excluded under applicable law, including any laws that do not permit limitations on liability relating to death or personal injury, the provisions of these terms and conditions shall be construed as being subject to such legal limitations, but only if those legal provisions have effect in relation to Tolomatic's liability notwithstanding the governing law provision in Section 18

Product Return Procedure

1. Before initiating the RMA process and obtaining an RMA number, please contact the Tolomatic Technical Support team to determine if it is possible to correct the issue in the field.
2. If an RMA is needed your Tolomatic Technical support team will initiate the RMA process and set up an RMA number. If possible, please contact your local distributor from which the actuator was originally purchased to begin the RMA process.

USA - Headquarters

Tolomatic Inc.
3800 County Road 116
Hamel, MN 55340, USA
Phone: (763) 478-8000
Toll Free: **1-800-328-2174**
sales@tolomatic.com
www.tolomatic.com

MEXICO

Centro de Servicio
Parque Tecnológico Innovación
Int. 23, Lateral Estatal 431,
Santiago de Querétaro,
El Marqués, México, C.P. 76246
Phone: +1 (763) 478 8000
help@tolomatic.com

EUROPE

Tolomatic Europe GmbH
Elisabethenstr. 20
65428 Rüsselsheim
Germany
Phone: +49 6142 17604-0
help@tolomatic.eu

CHINA

Tolomatic Automation Products (Suzhou) Co. Ltd.
No. 60 Chuangye Street, Building 2
Huqiu District, SND Suzhou
Jiangsu 215011 P.R. China
Phone: +86 (512) 6750-8506
tolomaticChina@tolomatic.com

APPENDIX D: DECLARATION OF CONFORMITY

CE



CE

EU Declaration of Conformity

No: 36004709_03

We the manufacturer,

Tolomatic
3800 County Road 116
Hamel, MN 55340
USA

declare under our sole responsibility that the product(s),

IMA Actuators

All Models

Fulfills the essential requirements of the following directives:

LVD Directive (2014/35/EU)

EN 60034-1:2010/AC:2010 Rotating electrical machines Part 1 Rating and performance

RoHS Directive (2011/65/EU, as amended by (EU) 2015/863)

REACH (Regulation (EC) No 1907/2006)

Assumption of conformity is based on the application of the harmonized or applicable technical standards and, when applicable or required, a European community notified body certification.

Brad Schulz
Director of Engineering & Technology

28.10.2022
Date (dd.mm.yyyy)

© 2022 Tolomatic

Tolomatic. All rights reserved.

Tolomatic and Excellence In Motion are registered trademarks of Tolomatic Incorporated. All other products or brand names are trademarks of their respective holders.

www.tolomatic.com



**COMPANY WITH
QUALITY SYSTEM
CERTIFIED BY DNV GL
= ISO 9001 =
Certified site: Hamel, MN**

USA - Headquarters	MEXICO	EUROPE	CHINA
Tolomatic Inc. 3800 County Road 116 Hamel, MN 55340, USA Phone: (763) 478-8000 Toll Free: 1-800-328-2174 sales@tolomatic.com www.tolomatic.com	Centro de Servicio Parque Tecnológico Innovación Int. 23, Lateral Estatal 431, Santiago de Querétaro, El Marqués, México, C.P. 76246 Phone: +1 (763) 478-8000 help@tolomatic.com	Tolomatic Europe GmbH Elisabethenstr. 20 65428 Rüsselsheim Germany Phone: +49 6142 17604-0 help@tolomatic.eu	Tolomatic Automation Products (Suzhou) Co. Ltd. No. 60 Chuangye Street, Building 2 Huqiu District, SND Suzhou Jiangsu 215011 P.R. China Phone: +86 (512) 6750-8506 tolomatic.china@tolomatic.com

All brand and product names are trademarks or registered trademarks of their respective owners. Information in this document is believed accurate at time of printing. However, Tolomatic assumes no responsibility for its use or for any errors that may appear in this document. Tolomatic reserves the right to change the design or operation of the equipment described herein and any associated motion products without notice. Information in this document is subject to change without notice.

Visit www.tolomatic.com for the most up-to-date technical information